



4

4.1

4.2

4.3

4.4

4.5

4.6

4.7

*4.8



4

- 1.**
- 2.**
- 3.**

4.1

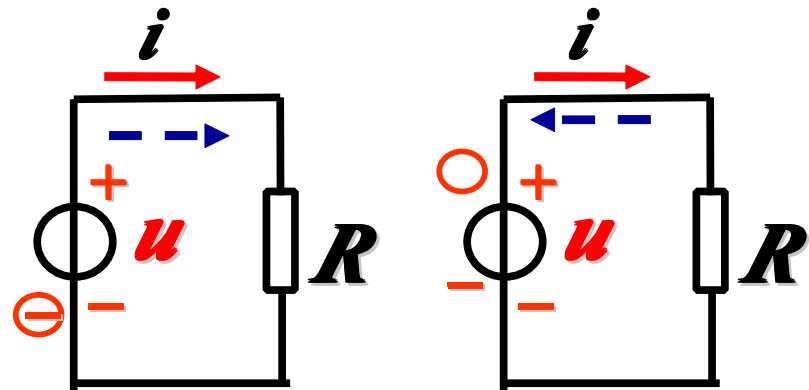
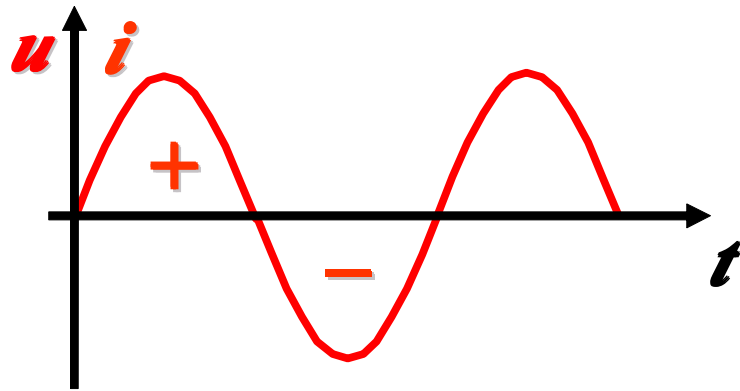

;

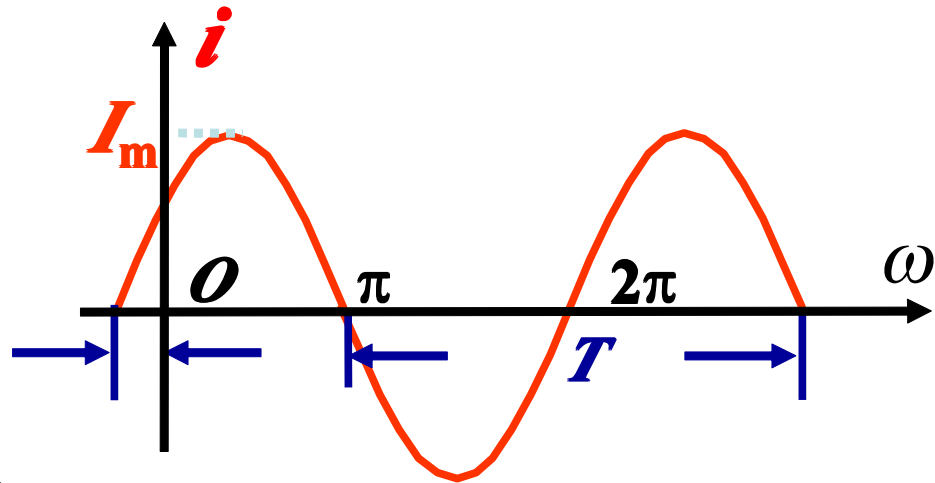

= $(\omega + \varphi)$



4.1.1 $i = I_m \sin(\omega t + \phi)$ $I_m = \sqrt{2} I$

$$i = I_m \sin(\omega t + \phi) = \sqrt{2} I \sin(\omega t + \phi)$$

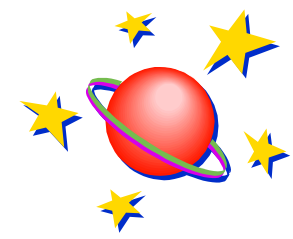
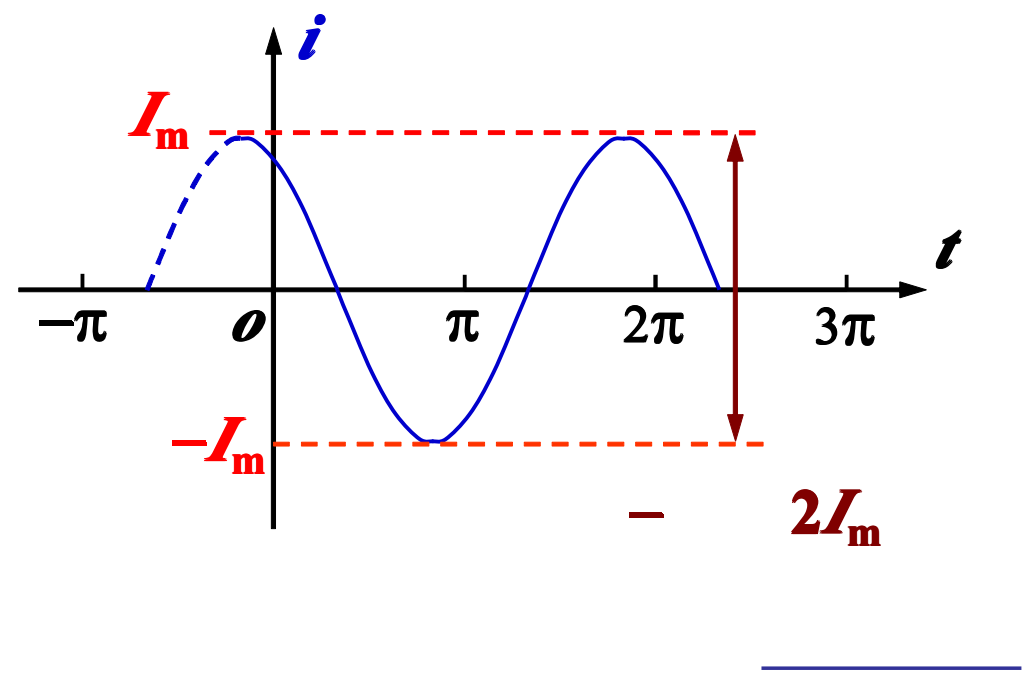



T $\int_0^T i^2 R dt \xrightarrow{\text{def}} I \sqrt{\frac{1}{T} \int_0^T i^2 dt}$

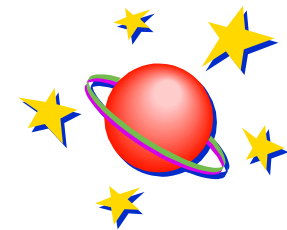

$i = I_m \sin(\omega t + \phi)$

$I_m = \sqrt{2} I$

$U_m = \sqrt{2} U$

$U = 220V$

$U_m = 311V$



i ***u*** ***I_m*** ***U_m*** ***I*** ***U***
 $I_M (I_{\max})$

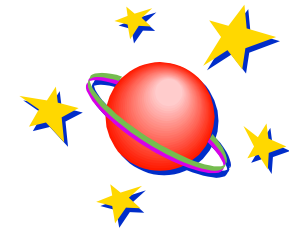

4.1.2



f

f

$T()$

$$i = I_m \sin(t + \phi)$$



Hz

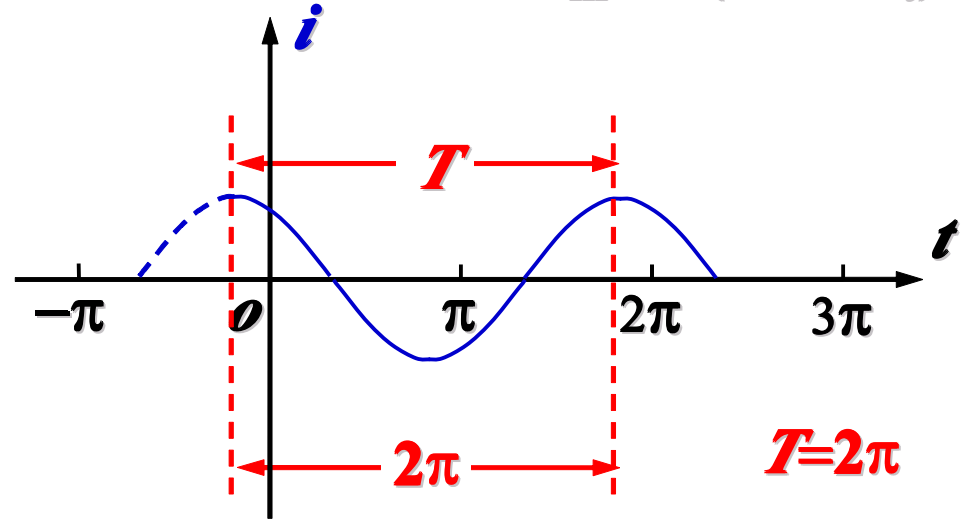

T

s

rad/s

$$= 2\pi f \quad f = \frac{1}{T} \quad T = \frac{1}{f}$$

4.1.3

()

$$\omega t + \varphi$$



4.1.4

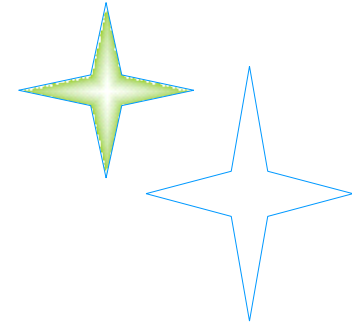

$$i = I_m \sin(\omega t + \psi_2)$$

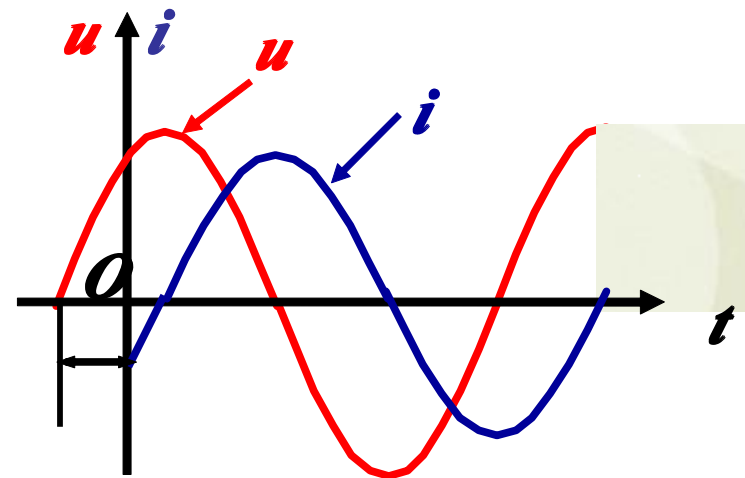

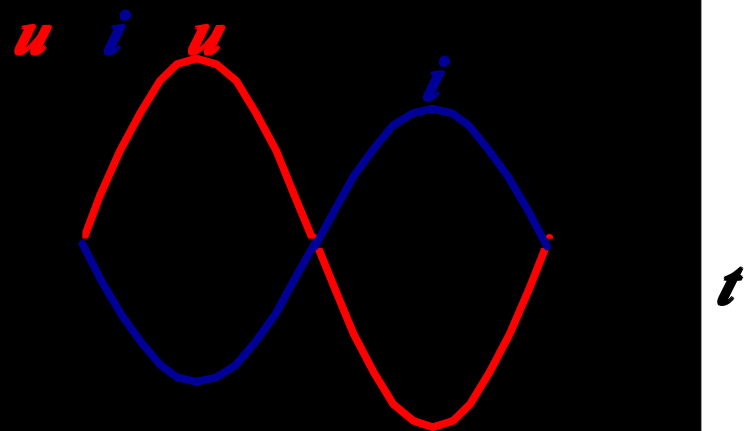
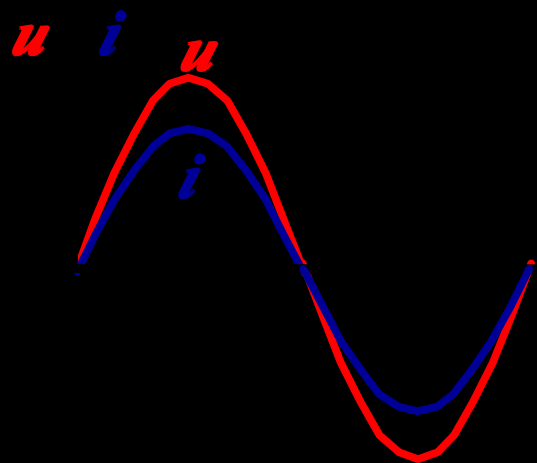
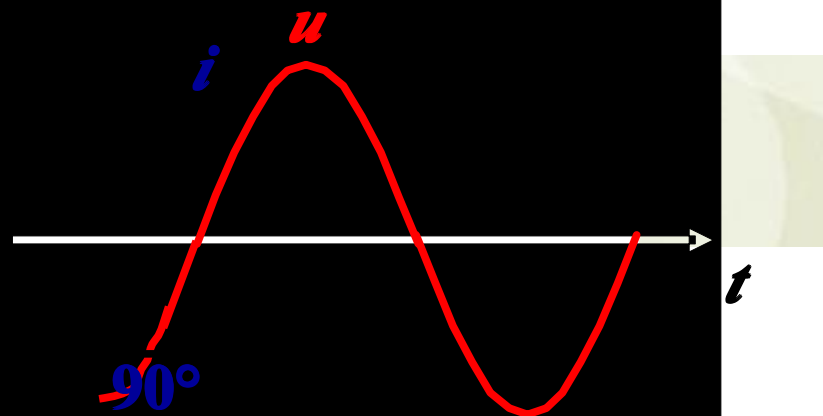
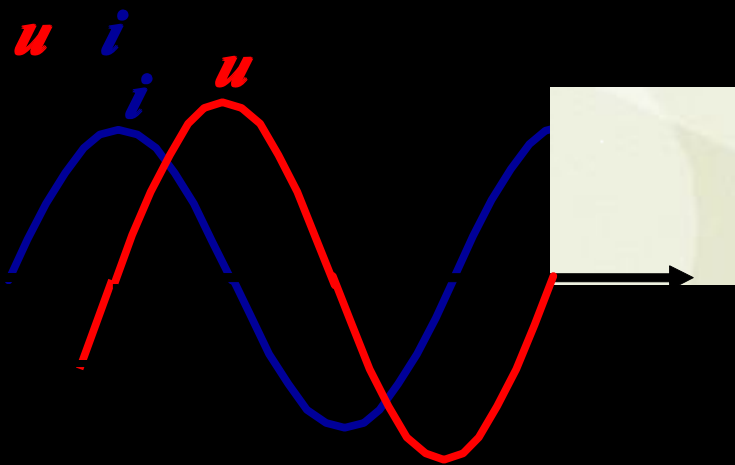

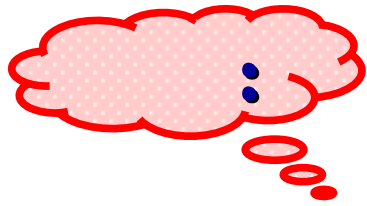

(1)

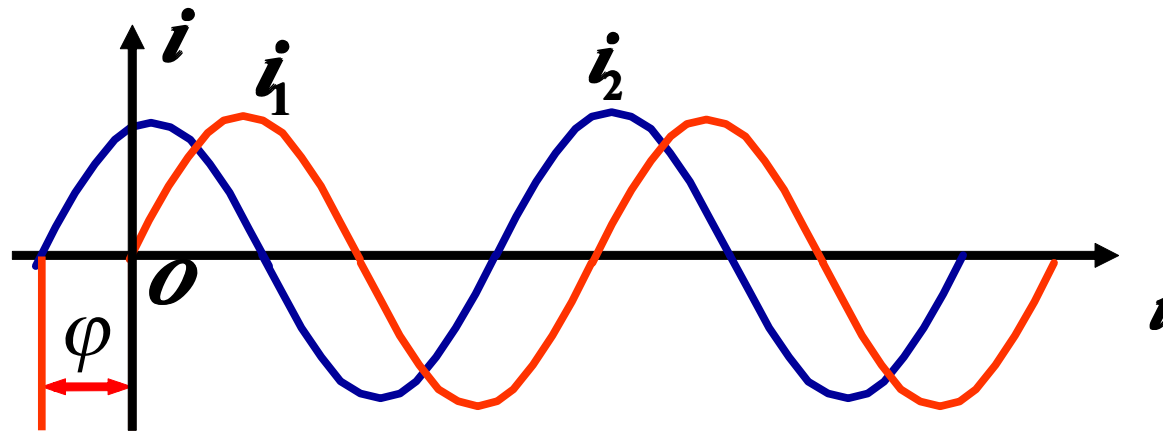
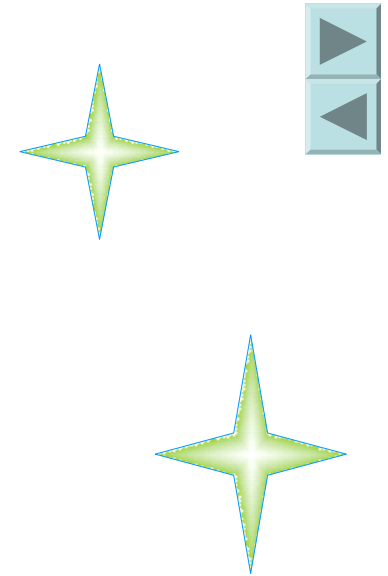

(2)

4.2



4.2.1

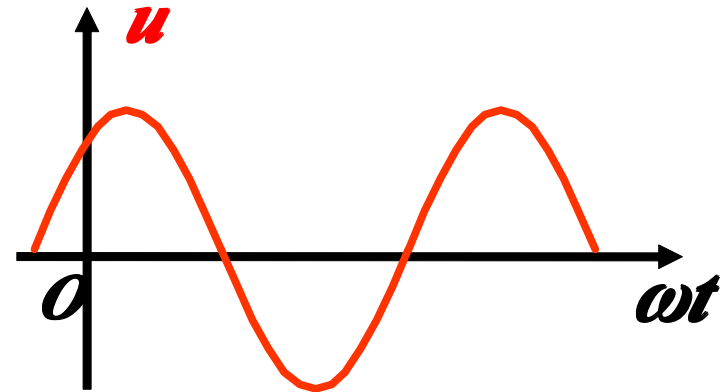

$$u = U_m \sin(\omega t + \psi)$$

$$U = U \psi$$

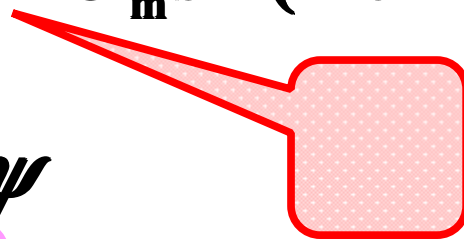

4.2.2

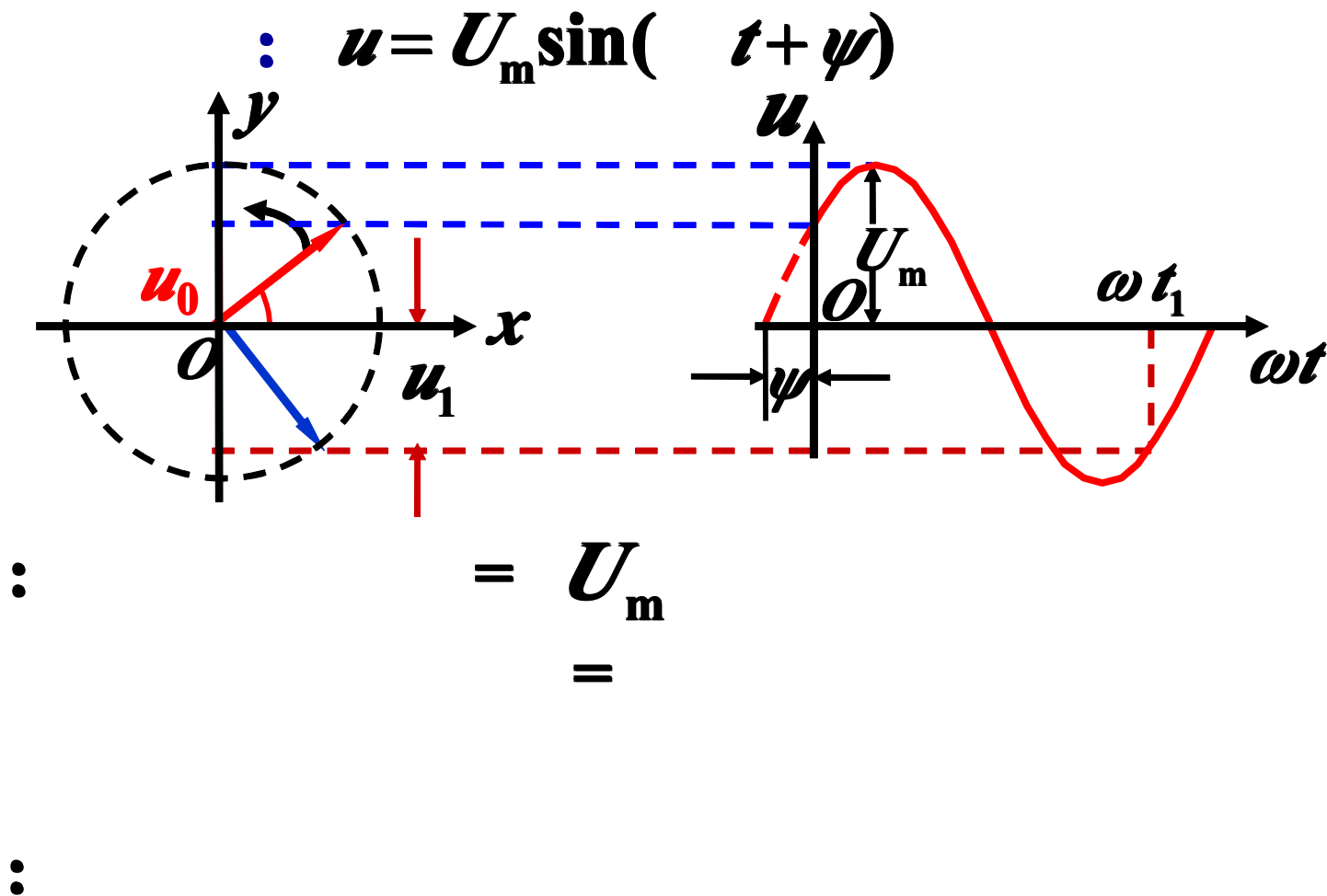



$$: e^{j\psi} = \cos \psi + j \sin \psi$$

$$(3) \quad A = r e^{j\psi}$$

$$(4) \quad A = r \angle \psi$$

$$A = a + jb = r \cos \psi + jr \sin \psi = r e^{j\psi} = r \angle \psi$$

:

$$: u = U_m \sin(\omega t + \psi)$$

:

$$U = U e^{j\psi} = U \angle \psi \left\{ \begin{array}{l} = \\ = \end{array} \right.$$

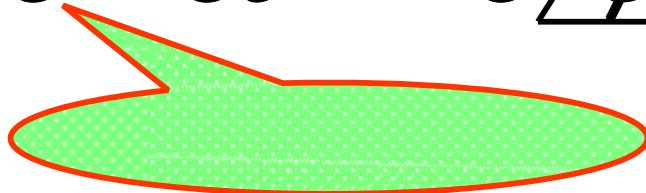



$$U_m = U_m e^{j\psi} = U_m \angle \psi \left\{ \begin{array}{l} = \\ = \end{array} \right.$$



(1)

$$i = I_m \sin(\omega t + \psi) \neq I_m e^{j\psi} = I_m \psi$$

(2)

(3)



(4)

$$\therefore U = U e^{j\psi} = U \angle \psi = U(\cos \psi + j \sin \psi)$$

:

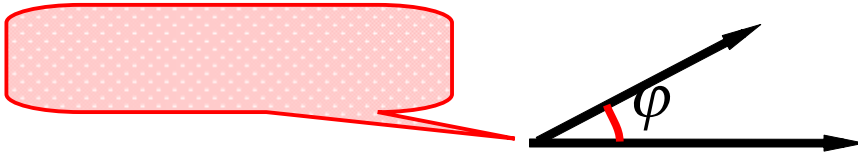

(5)

$$U_m \quad I_m$$

$$U \quad I$$

$$u = 220 \sin(\omega t + 45^\circ) \text{ V}$$

$$U_m = 220 e^{j45^\circ} \text{ V} \quad U = \frac{220}{\sqrt{2}} e^{j45^\circ} \text{ V}$$



(6)



1



$e^{j\theta}$

$e^{j\theta}$

$$e^{j\theta} = 1 \quad \theta$$

q

$$A = |A| e^{j\theta_a}$$

A

|A|

θ

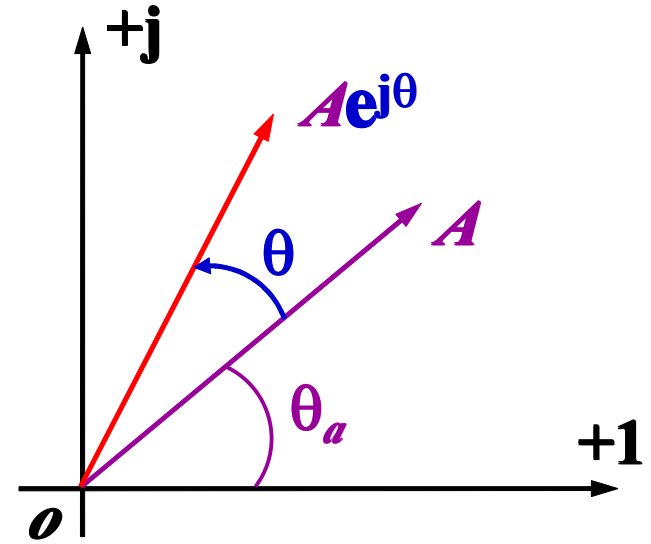

$$\left. \begin{aligned} e^{j\frac{\pi}{2}} &= j \\ e^{-j\frac{\pi}{2}} &= -j \\ e^{j\pi} &= -1 \end{aligned} \right\}$$

$$A \quad j = jA \quad A$$

90°.

$$\frac{A}{j} = -jA \quad A$$

90°.



1.

$$u = 220 \sin(\omega t + 45^\circ) \text{ V}$$

$$\dot{U} \neq \frac{220}{\sqrt{2}} \angle 45^\circ \text{ V}$$

$$U_m \neq 220 e^{j45} \text{ V}$$

2.

$$I = 10 \angle 60^\circ \text{ A}$$

$$i \neq 10 \sin(\omega t + 60^\circ) \text{ A}$$

3.

$$I = 4 e^{j30} \text{ A}$$

$$\neq 4\sqrt{2} \sin(\omega t + 30^\circ) \text{ A}$$

4.

$$U = 100 \angle -15^\circ \text{ V}$$

$$U = 100 \text{ V}$$

$$U \neq 100 e^{j15} \text{ V}$$



例1:

(1)

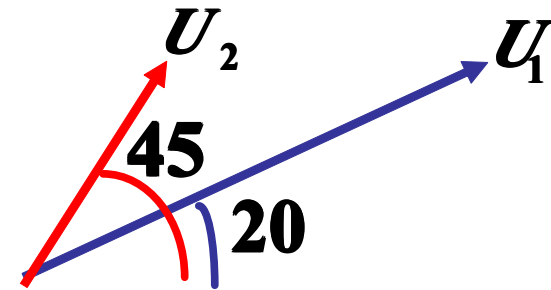

(2)



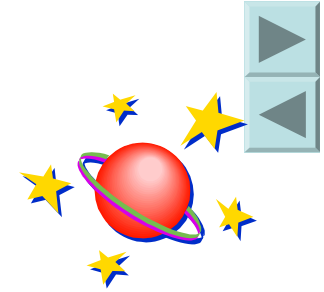

$$2: \quad i_1 = 12.7\sqrt{2} \sin(314t + 30^\circ) \text{ A}$$

$$i_2 = 11\sqrt{2} \sin(314t - 60^\circ) \text{ A}$$

$$i = i_1 + i_2$$

$$I_1 = 12.7 \angle 30 \text{ A}$$

$$I_2 = 11 \angle -60 \text{ A}$$

$$I = I_1 + I_2 = 12.7 \angle 30 \text{ A} + 11 \angle -60 \text{ A}$$

$$= 12.7(\cos 30 + j \sin 30) \text{ A} + 11(\cos 60 - j \sin 60) \text{ A}$$

$$= (16.5 - j3.18) \text{ A} = 16.8 \angle -10.9 \text{ A}$$

$$i = 16.8\sqrt{2} \sin(314t - 10.9^\circ) \text{ A}$$

$$I = 16.8 \text{ A}$$



4.3

4 3 1

$$: u = iR$$

$$u = U_m \sin \omega t$$

$$i = \frac{u}{R} = \frac{U_m \sin \omega t}{R} = \frac{\sqrt{2}U}{R} \sin \omega t$$
$$= I_m \sin \omega t = \sqrt{2} I \sin \omega t$$

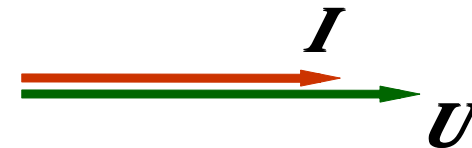
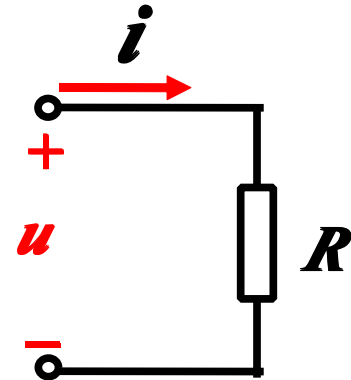

(1)

(2)

$$I = \frac{U}{R}$$

(3)

$$u \quad i$$

$$= u - i = 0$$

$$I = \underline{I/0}$$

$$U = \underline{U/0} = I$$

4 3 2



$$u = -e_L = L \frac{di}{dt}$$

$$i = \sqrt{2} I \sin \omega t$$

$$u = L \frac{d(I_m \sin \omega t)}{dt}$$

$$= \sqrt{2} \underline{I \omega L} \sin(\omega t + 90^\circ)$$

$$= \sqrt{2} \underline{U} \sin(\omega t + 90^\circ)$$

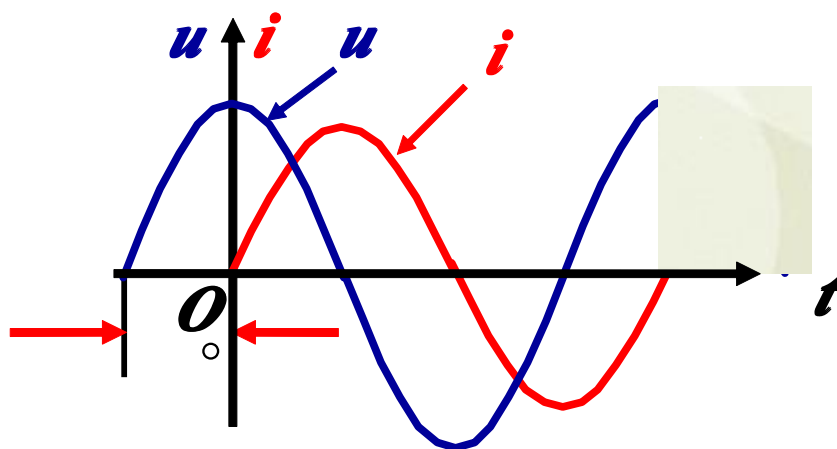
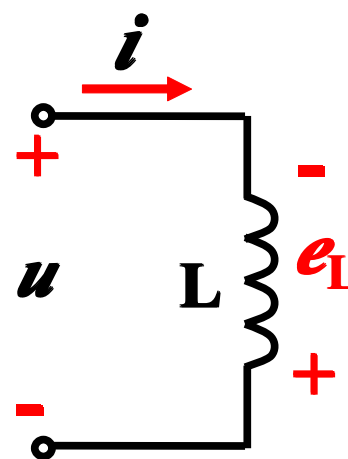

- (1)
- (2) $U = I L$
- (3) $\varphi = \psi_u - \psi_i = 90$



$$\begin{cases} i = \sqrt{2} I \sin \omega t \\ u = \sqrt{2} I \omega L \sin (\omega t + 90^\circ) \end{cases}$$

$$: U = I \cdot \omega L \qquad I = \frac{U}{L}$$

$$X_L = \omega L = 2\pi fL$$

$$U = I X_L$$

$$X_L = 2\pi fL \left\{ \begin{array}{l} f = 0, X_L = 0 \quad L \\ f \uparrow \longrightarrow X_L \uparrow \end{array} \right.$$

$$\therefore L$$



$$X_L = \omega L = 2\pi f L$$

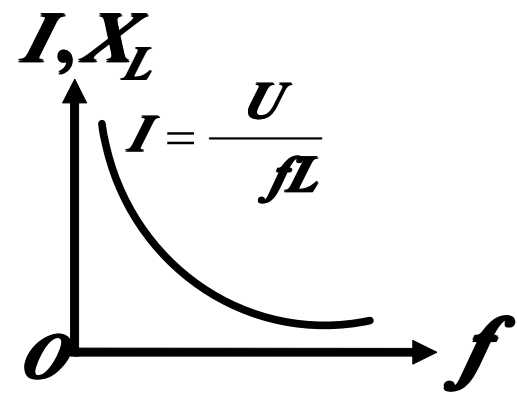

$$\begin{cases} i = \sqrt{2} I \sin \omega t \\ u = \sqrt{2} I \omega L \sin (\omega t + 90^\circ) \end{cases}$$

$$I = I / 0$$

$$U = U / 90 = I \omega L / 90$$

$$\frac{U}{I} = \frac{U}{I} / 90 = j L$$

$$U = j I \omega L = (j X_L)$$

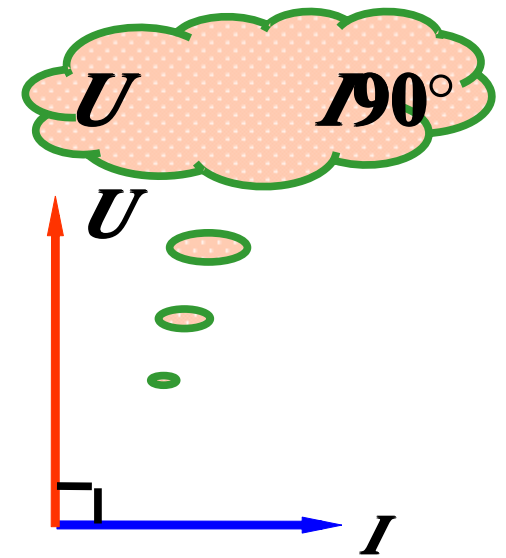

4 3 3



$$i = C \frac{du}{dt}$$

$$u = \sqrt{2} U \sin \omega t$$

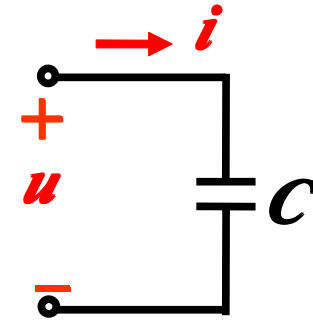

$$i = C \frac{du}{dt} = \sqrt{2} UC \omega \cos \omega t$$

$$= \sqrt{2} U \omega C \sin(\omega t + 90^\circ)$$

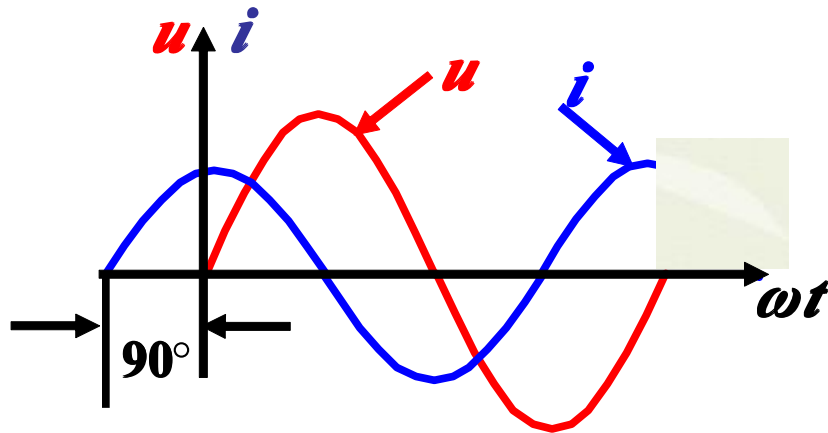
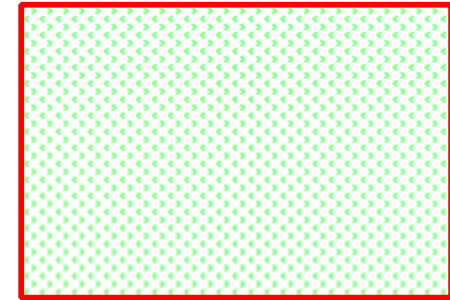

(1)

(2) $I = U C$

(3)

90

$$\varphi = \psi_u - \psi_i = - 90^\circ$$





$$X_c = \frac{1}{2\pi f C}$$

X_c

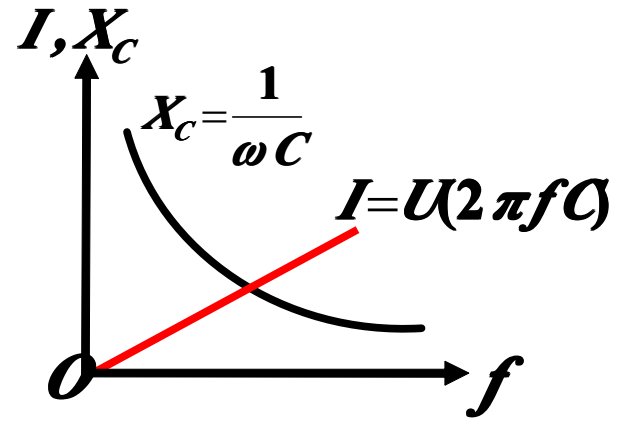

$$\begin{cases} u = \sqrt{2} U \sin \omega t \\ i = \sqrt{2} U \omega C \sin (\omega t + 90^\circ) \end{cases}$$

$$= \angle^\circ = \omega$$

$$U = -j I \frac{1}{\omega C} = -j X_c$$

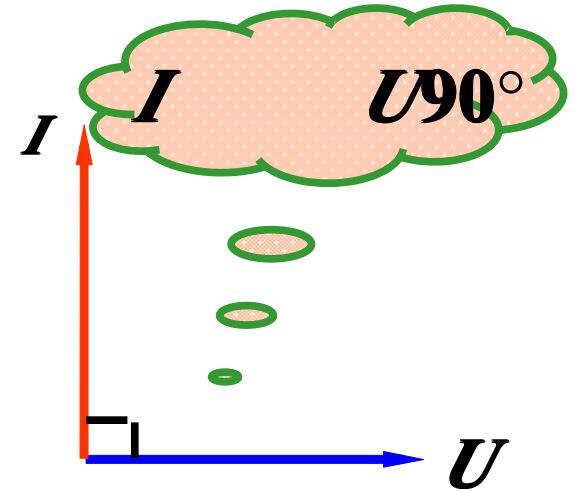



小结

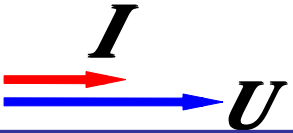
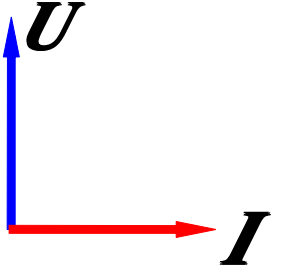
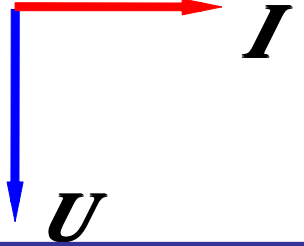

<i>R</i>	<i>R</i>	$u = iR$	$U = IR$	
<i>L</i>	$jX_L = j\omega L$	$u = L \frac{di}{dt}$	$U = jX_L I$	
<i>C</i>	$-jX_C = -j \frac{1}{\omega C}$	$i = C \frac{du}{dt}$	$U = -jX_C I$	

4.4



$$R \rightarrow R \quad L \rightarrow j\omega L \quad C \rightarrow -j\frac{1}{\omega C}$$



$$U = IR$$

$$U = I(jX_L)$$

$$U = I(-jX_C)$$

$$U = IZ$$



KCL

$$I = 0$$

KVL

$$U = 0$$

4.4.1

(1)

$$\dot{U} = U \angle u \quad \dot{I} = I \angle i$$

$$Z \stackrel{\text{def}}{=} \frac{\dot{U}}{\dot{I}} = \frac{U}{I} \angle u - i = |Z| \angle z$$

$$|Z| = \frac{U}{I}$$

$|Z|$

$$z = u - i \quad \circ \quad z$$

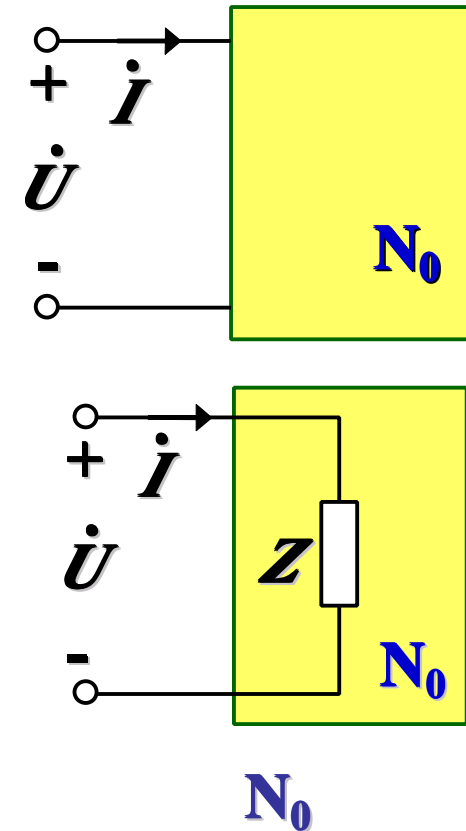



(2)

$$\mathbf{Z} = |\mathbf{Z}| e^{j z}$$

$$\mathbf{Z} = |\mathbf{Z}| \angle z$$

$$\mathbf{Z} = |\mathbf{Z}| \cos z + j |\mathbf{Z}| \sin z$$

$$\mathbf{Z} = R + j X$$

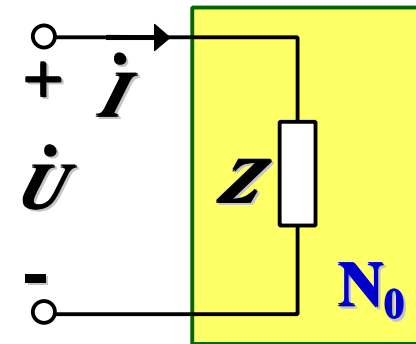

\mathbf{Z} R

\mathbf{Z} X

$$\begin{cases} R = |\mathbf{Z}| \cos z \\ X = |\mathbf{Z}| \sin z \end{cases}$$

$$\begin{cases} |\mathbf{Z}| = \sqrt{R^2 + X^2} \\ z = \arctg \frac{X}{R} \end{cases}$$

$|\mathbf{Z}|$ R X

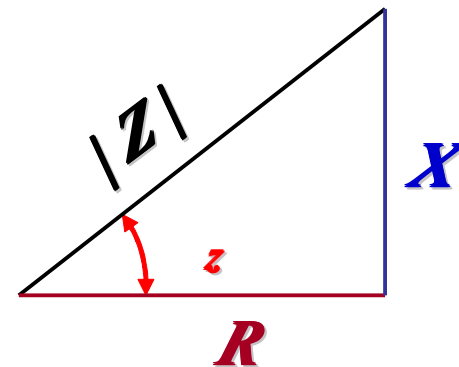

(3)



$$Z = \frac{\dot{U}}{\dot{I}} = R$$



$$Z = \frac{\dot{U}}{\dot{I}} = jL = jX_L$$

$$X_L = L$$



$$Z = \frac{\dot{U}}{\dot{I}} = \frac{1}{jC} = -j \frac{1}{C} = -jX_C$$

$$X_C = \frac{1}{C}$$



Z

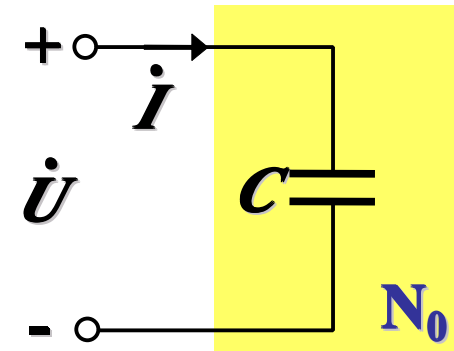
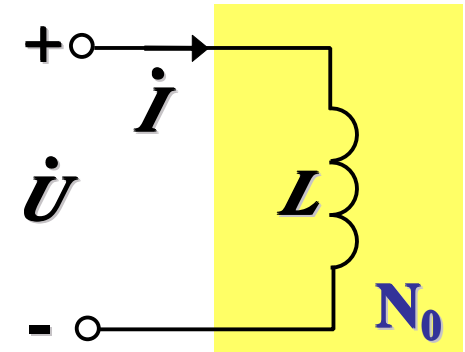
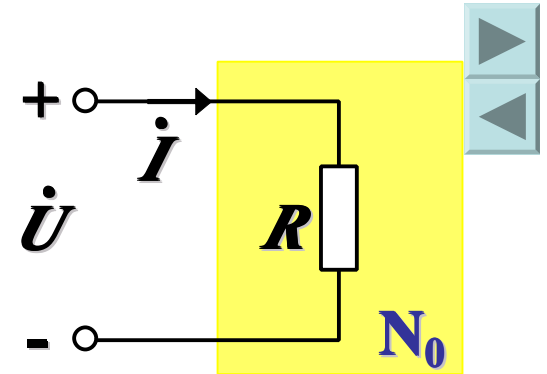
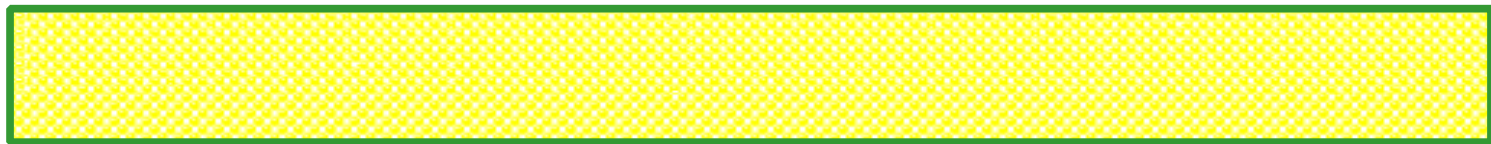

(4) RLC

KVL VCR

$$\dot{U} = R\dot{i} + jL\dot{i} - j\frac{1}{C}\dot{i}$$

$$= \left[R + jL - j\frac{1}{C} \right] \dot{i} = [R + j(X_L - X_C)] \dot{i}$$

$$= (R + jX) \dot{i} = Z\dot{i}$$

$$Z = \frac{\dot{U}}{\dot{i}} = R + jX = |Z| \angle z$$

$$X = X_L - X_C = L - \frac{1}{C} \quad z = \arctg \frac{X}{R}$$

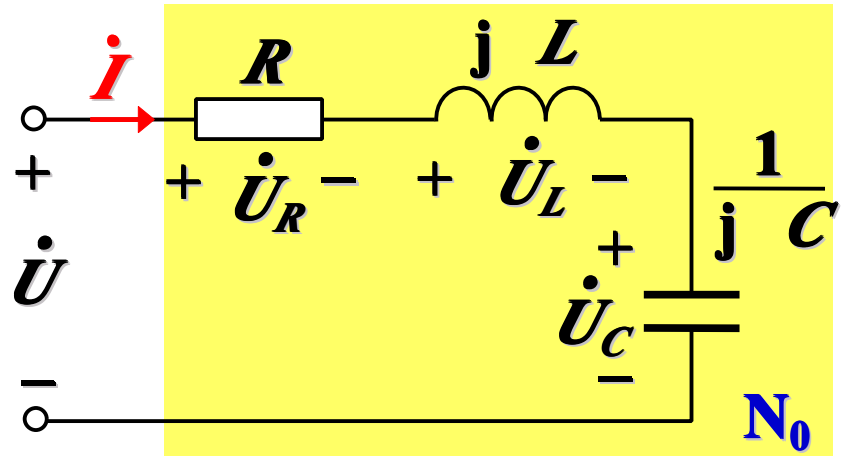

$$\mathbf{Z} = \frac{\dot{U}}{\dot{I}} = R + jX = |\mathbf{Z}| \angle z$$

$$X = X_L - X_C = L - \frac{1}{C}$$

$$z = \arctg \frac{X}{R}$$

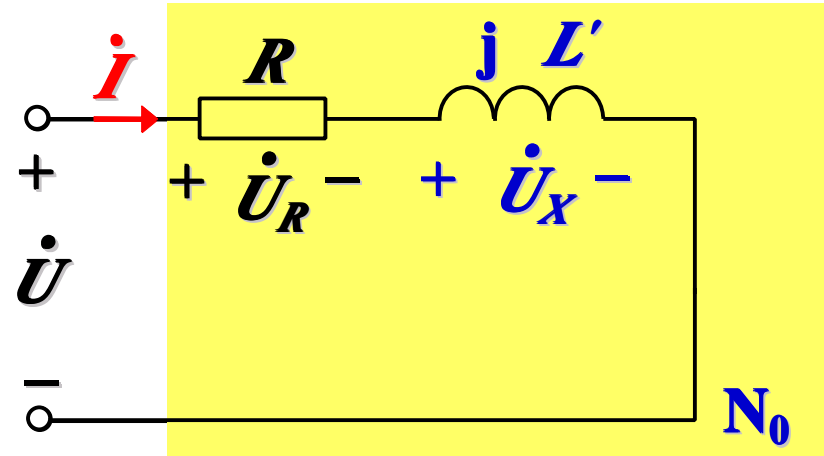

$$\begin{matrix} L & \frac{1}{C} \\ X & 0 \\ Z & z \end{matrix}$$

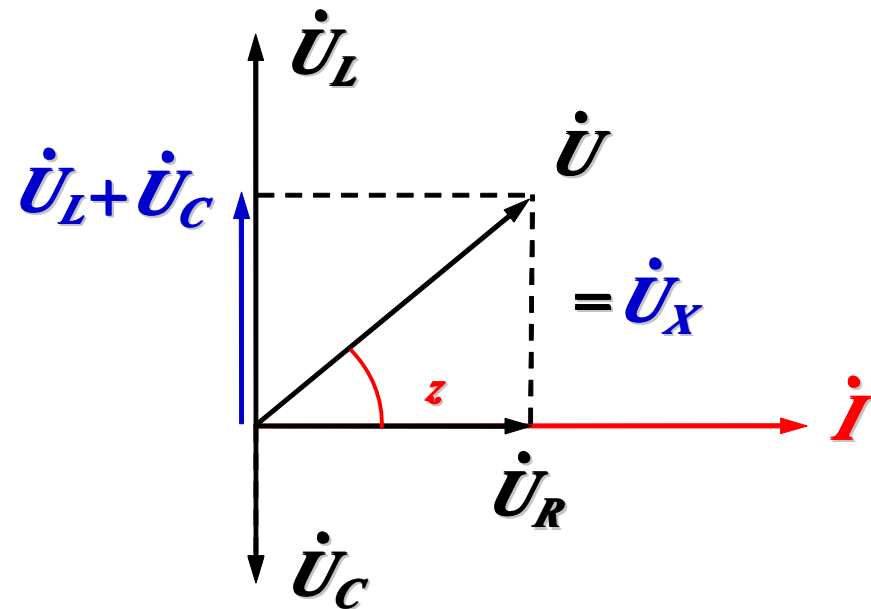

$$\mathbf{Z} = \frac{\dot{U}}{\dot{I}} = R + jX = |\mathbf{Z}| \angle \varphi_z$$

$$X = X_L + X_C = L\omega - \frac{1}{C\omega}$$

$$\varphi_z = \arctg \frac{X}{R}$$

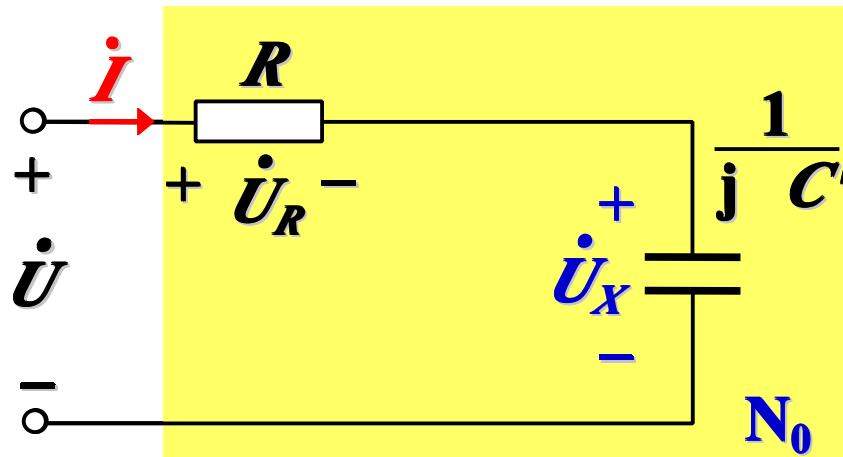

$$\mathbf{Z} = R + j\left(L\omega - \frac{1}{C\omega}\right)$$

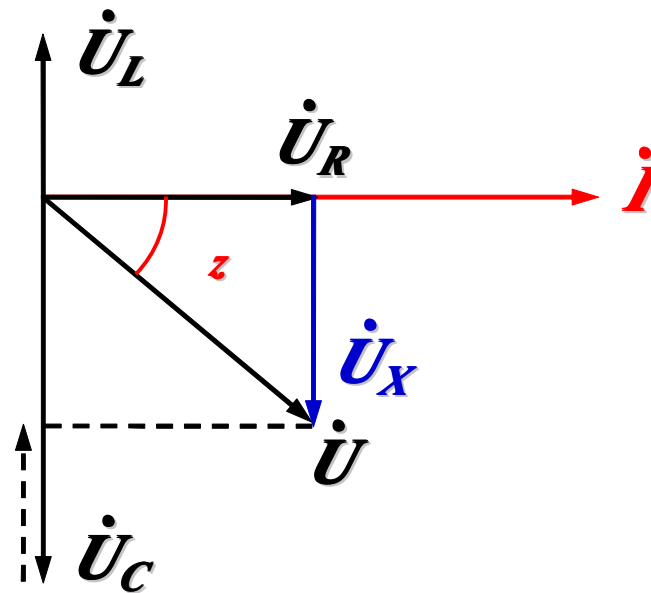

$$\mathbf{Z} = \frac{\dot{U}}{\dot{I}} = R + jX = |\mathbf{Z}| \angle z$$

$$X = X_L + X_C = L - \frac{1}{C}$$

$$z = \arctg \frac{X}{R}$$

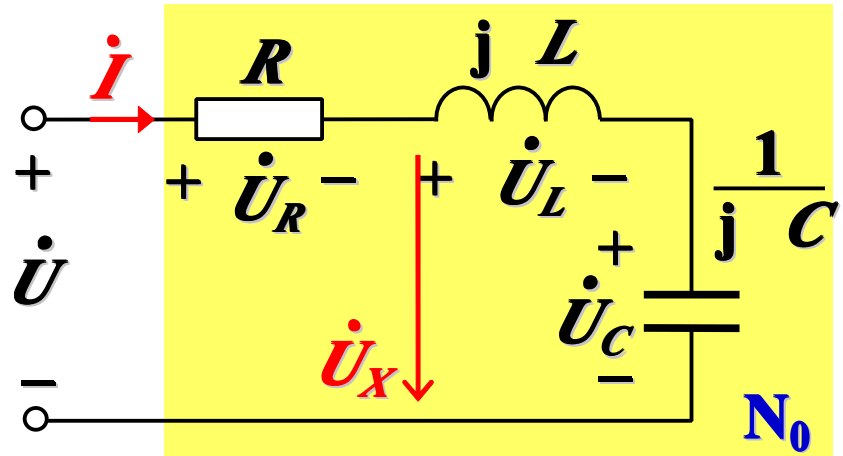

$$R=0 \quad X>0 \quad \mathbf{Z}$$

$$R=0 \quad X<0 \quad \mathbf{Z}$$

☞ RLC

$$U_X \quad U$$

$$U = \sqrt{U_R^2 + U_X^2}$$

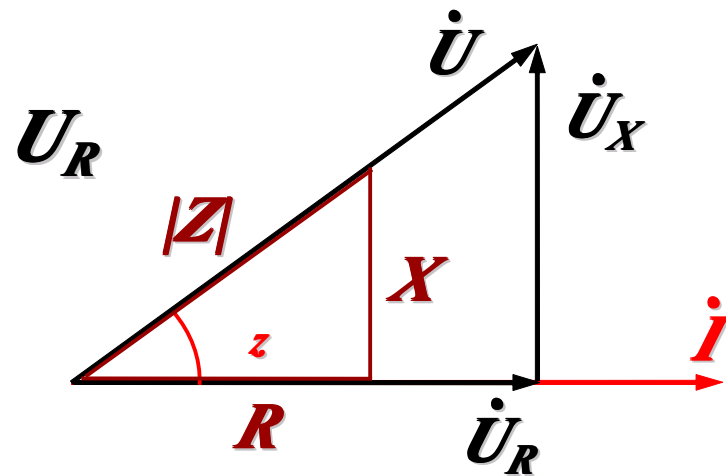

4.4.2

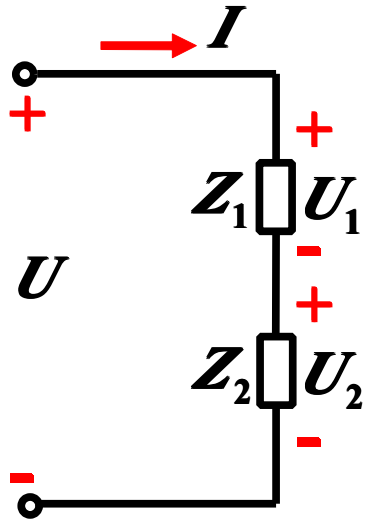

$$U = U_1 + U_2 = Z_1 I + Z_2 I$$

$$= (Z_1 + Z_2) I$$

$$Z = Z_1 + Z_2 \quad I = \frac{U}{Z}$$

$$\therefore Z = Z_k = R_k + j X_k$$

$$|Z| = |Z_1| + |Z_2|$$

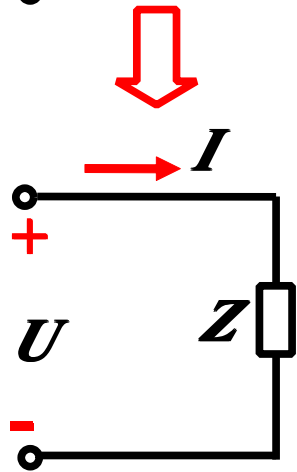

$$U_1 = \frac{Z_1}{Z_1 + Z_2} U \quad U_2 = \frac{Z_2}{Z_1 + Z_2} U$$

4.4.3

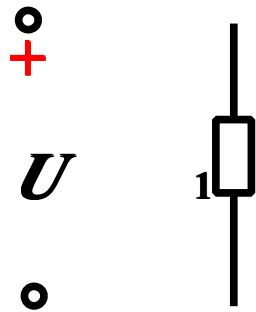

$$I = I_1 + I_2 = \frac{U}{Z_1} + \frac{U}{Z_2}$$

$$I = \frac{U}{Z} \quad \frac{1}{Z} = \frac{1}{Z_1} + \frac{1}{Z_2}$$

$$Z = \frac{Z_1 Z_2}{Z_1 + Z_2}$$

$$\frac{1}{|Z|} \neq \frac{1}{|Z_1|} + \frac{1}{|Z_2|}$$

? Ö

$$I_2 = \frac{Z_1}{Z_1 + Z_2} I$$





RLC

$$I = I/0$$

$I = \frac{U}{ Z }$	$\varphi = \arctan \frac{U_L - U_C}{U_R}$	$I = \frac{U}{R + X_L + X_C}$
$I = \frac{U}{Z}$		$U = U_R + U_L + U_C$
$I = \frac{U}{Z}$	$\varphi = \arctan \frac{X_L - X_C}{R}$	$u = u_R + u_L + u_C$
$i = \frac{u}{ Z }$	$\varphi = \arctan \frac{\omega L - \omega C}{R}$	$Z = R + X_L + X_C$
$I = \frac{U}{ Z }$	$\varphi = \arctan \frac{U_L - U_C}{U}$	$Z = R + j(X_L + X_C)$



1. ()

$$\begin{aligned} R &\rightarrow R, & L &\rightarrow jX_L, & C &\rightarrow -jX_C \\ u &\rightarrow U, & i &\rightarrow I, & e &\rightarrow E \end{aligned}$$

2.

3.

4.



1 : $u = 220 \sqrt{2} \sin \omega t \text{ V}$

$R = 50 \text{ } \Omega, R_1 = 100 \text{ } \Omega, X_L = 200 \text{ } \Omega, X_C = 400 \text{ } \Omega$

: $i \quad i_1 \quad i_2$

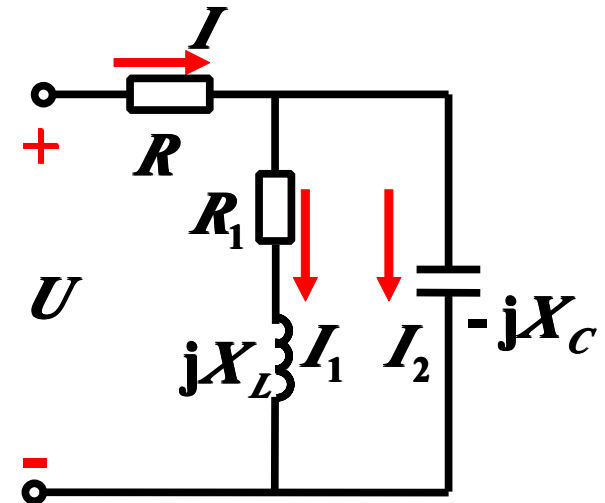

$U = 220 \angle 0 \text{ V}$

$Z_1 = R_1 + jX_L = 100 + j200 \text{ } \Omega$

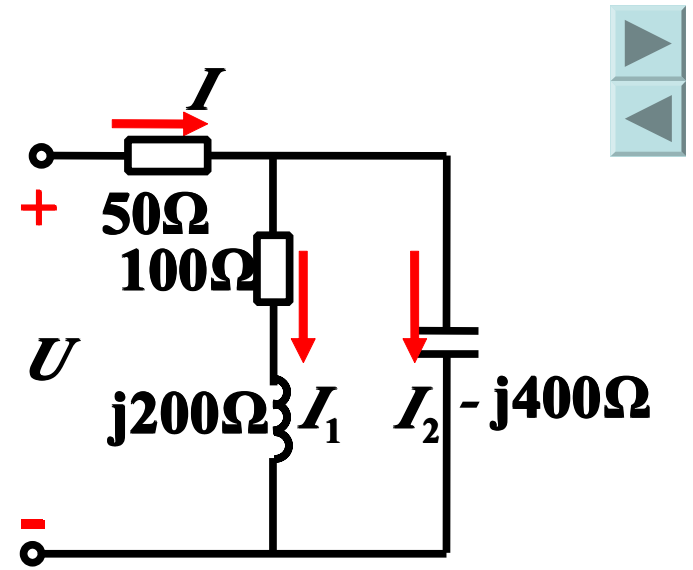



$$\begin{aligned} I_2 &= \frac{Z_1}{Z_1 + Z_2} \\ &= \frac{100 + j200}{100 + j200 - j400} \\ &= \underline{0.5 / 93.8^\circ} \text{ A} \end{aligned}$$

$$0.5 / -33^\circ \text{ A}$$

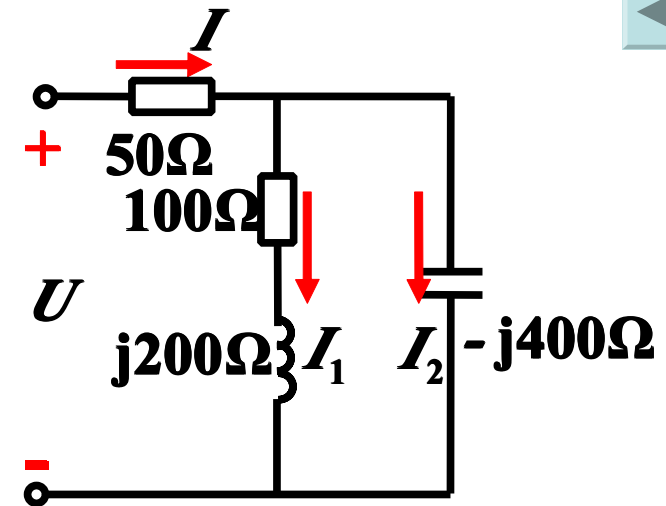

$$i = 0.5\sqrt{2} \sin(\omega t - 33^\circ) \text{ A}$$

$$i_1 = 0.89\sqrt{2} \sin(\omega t - 59.6^\circ) \text{ A}$$

$$i_2 = 0.5\sqrt{2} \sin(\omega t + 93.8^\circ) \text{ A}$$

2

$$I_1 = 10\text{A} \quad U_{AB} = 100\text{V}$$

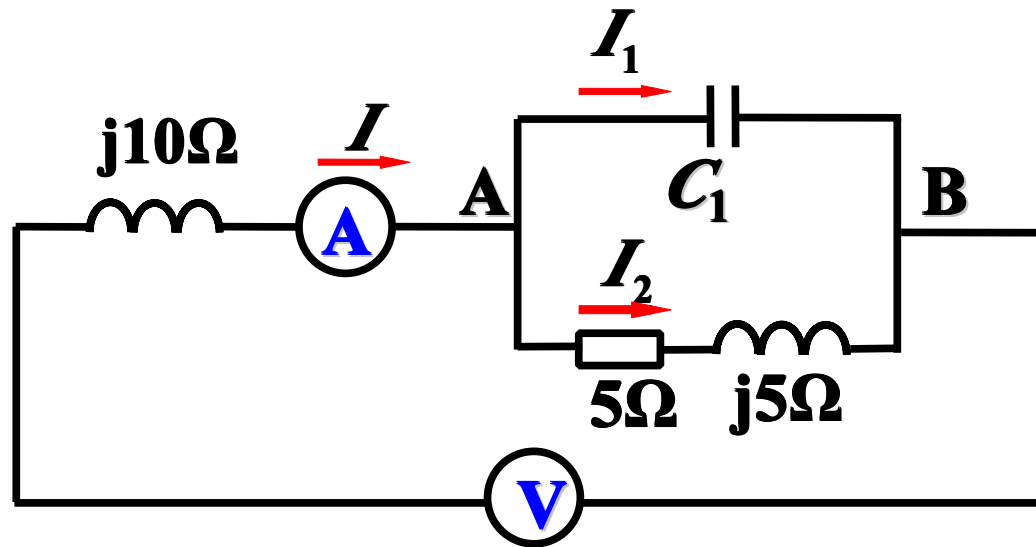

()

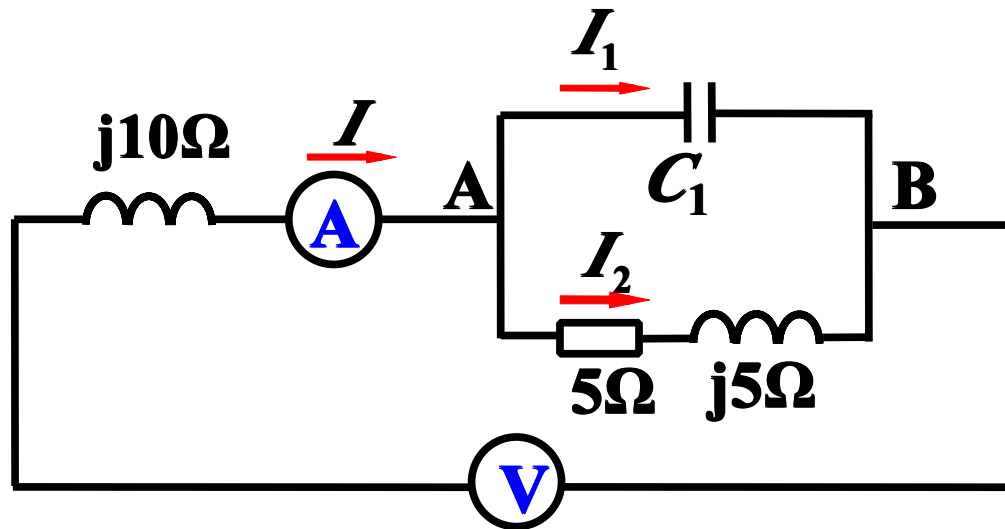

$$I_1 = 10 \text{ A}$$

$$U_{AB} = 100 \text{ V}$$

A V

∴ $U_{AB} = 100 \angle 0 \text{ V}$

$$I_2 = [100 / (5 + j5)] \text{ A} = 10\sqrt{2} \angle -45 \text{ A}$$

$$I_1 = 10 \angle 90 \text{ A} = j10 \text{ A}$$

$$I = I_1 + I_2 = 10 \angle 0 \text{ A}$$

A 10

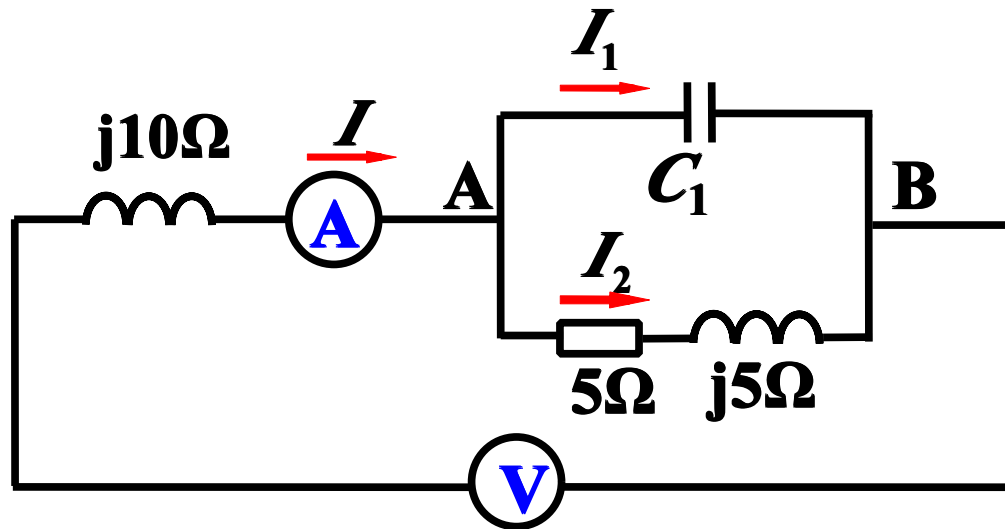

$$I_1 = 10 \text{ A}$$

$$U_{AB} = 100 \text{ V}$$

A V

$$I = I_1 + I_2 = 10 \angle 0 \text{ A}$$

$$U_L = I(j10) \text{ V} = j100 \text{ V}$$

$$U = U_L + U_{AB} = 100 + j100 \text{ V}$$

$$= 100\sqrt{2} \angle 45 \text{ V}$$

$$\therefore \text{V} \quad 141 \text{ V}$$

3

$$U = 200 \text{ V}, R = X_L,$$

$$I = I_2 = 10 \text{ A}$$

u i

: I, R, X_L, X_C

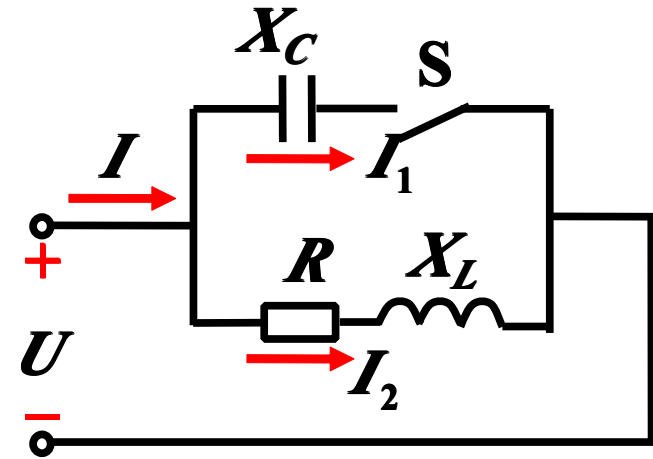

$$I_2 = \frac{U}{|Z|} = \frac{200}{\sqrt{R^2 + X_L^2}} = \frac{200}{\sqrt{2R}} = 10 \text{ A}$$

$$R = X_L = \frac{200}{10\sqrt{2}} = 10\sqrt{2} \Omega$$

$$I = I_2 \cos 45^\circ = 5\sqrt{2} \text{ A}$$

$$I_1 = I_2 \sin 45^\circ = 10 \times \sin 45^\circ = 5\sqrt{2} \text{ A}$$

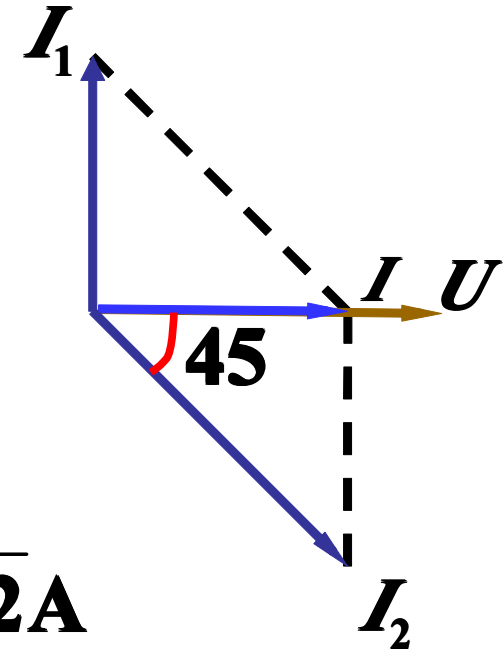

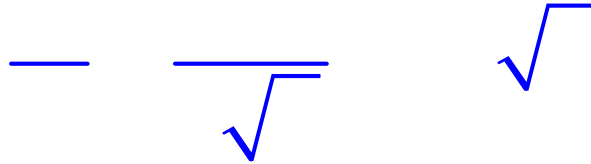

u ***i***

$$***I = I_1 + I_2***$$

$$***I = I_2 \cos 45^\circ \text{ A}***$$

$$***I_1 = I_2 \sin 45^\circ \text{ A}***$$



$$4: \quad \dot{I} = 18 \quad 45 \text{ A} \quad : \dot{U}_{AB}$$

$$: \dot{I}_1 = \frac{j8}{30+j8} \quad 18 \quad 45$$

$$= 4.64 \quad 120 \text{ A}$$

$$\dot{I}_2 = \frac{30}{30+j8} \quad 18 \quad 45$$

$$= 17.4 \quad 30 \text{ A}$$

$$\dot{U}_A = 20 \dot{I}_1 = 92.8 \quad 120 \text{ V}$$

$$\dot{U}_B = j6 \dot{I}_2 = 104.4 \quad 120 \text{ V}$$

$$\dot{U}_{AB} = \dot{U}_A - \dot{U}_B = 92.8 \quad 120 - 104.4 \quad 120$$

$$= -11.6 \quad 120 \text{ V} = 11.6 \quad -60 \text{ V}$$

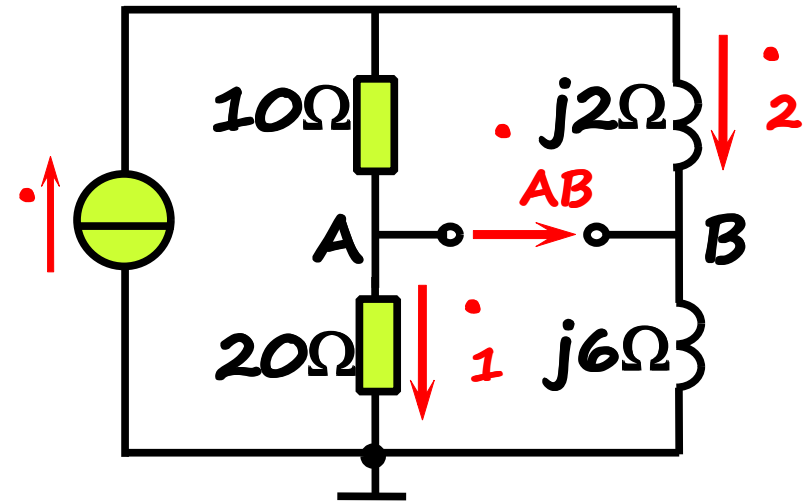

4.5

4.5.1.

1. p

$$i = \sqrt{2} I \sin \omega t$$

$$u = \sqrt{2} U \sin \omega t$$

$$\begin{aligned} p &= u \cdot i \\ &= U_m I_m \sin^2 \omega t \\ &= \frac{1}{2} U_m I_m (1 - \cos 2\omega t) \end{aligned}$$

$$\therefore p \geq 0$$

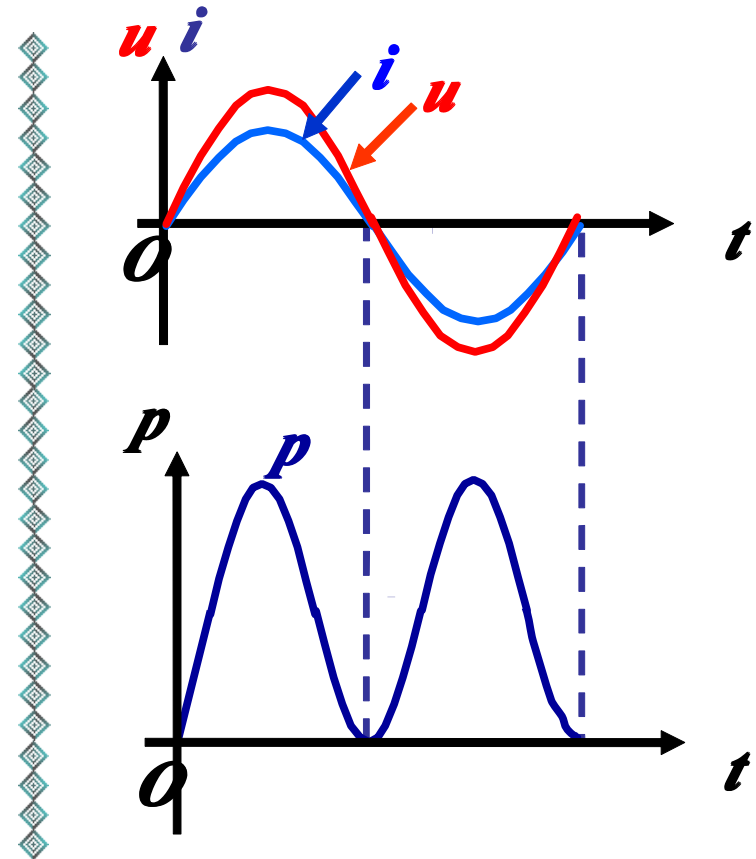

2. ()P

$$P = \frac{1}{T} \int_0^T p dt = \frac{1}{T} \int_0^T u \cdot i dt$$

$$= \frac{1}{T} \int_0^T \frac{1}{2} U_m I_m (1 - \cos 2\omega t) dt$$

$$= \frac{1}{T} \int_0^T UI (1 - \cos 2\omega t) dt = UI$$

$$P = UI \quad I = \sqrt{I^2 R} = \frac{U^2}{R}$$

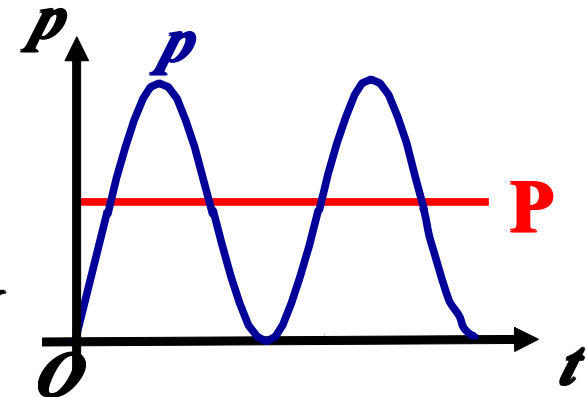
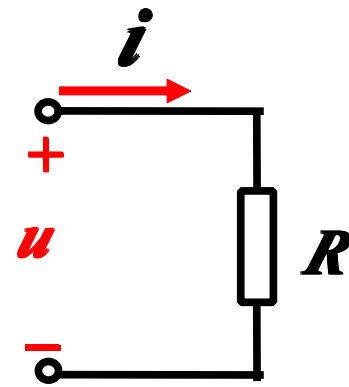

: W

4.5.2

$$\begin{cases} i = \sqrt{2} I \sin \omega t \\ u = \sqrt{2} I \omega L \cdot \sin (\omega t + 90^\circ) \end{cases}$$

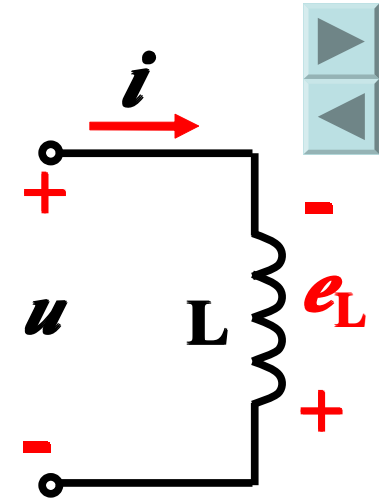

1.

$$\begin{aligned} p &= i \cdot u = U_m I_m \sin \omega t \sin (\omega t + 90^\circ) \\ &= U_m I_m \sin \omega t \cos \omega t = \frac{U_m I_m}{2} \sin 2 \omega t \\ &= UI \sin 2 \omega t \end{aligned}$$

2.

$$\begin{aligned} P &= \frac{1}{T} \int_0^T p dt \\ &= \frac{1}{T} \int_0^T UI \sin (2 \omega t) dt = 0 \end{aligned}$$

L



3.

Q

$$p = i \cdot u = UI \sin 2\omega t$$

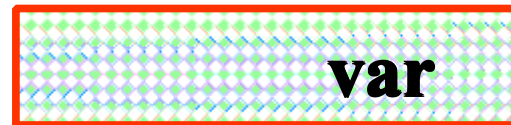
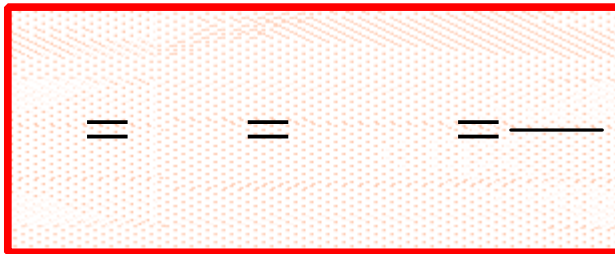

$$p = i \cdot u = UI \sin 2\omega t$$

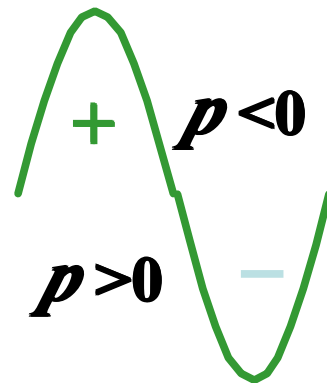

4.5.3

$$\begin{cases} u = \sqrt{2} U \sin \omega t \\ i = \sqrt{2} U \omega C \sin (\omega t + 90^\circ) \end{cases}$$

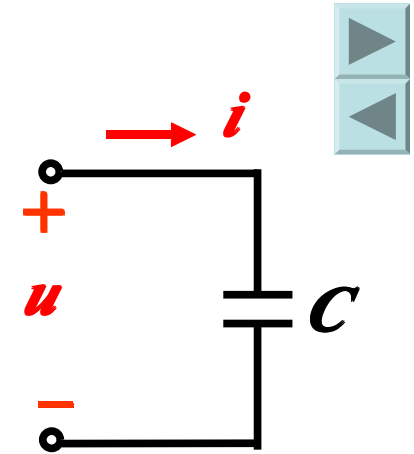

1.

$$\begin{aligned} p &= i \cdot u = U_m I_m \sin \omega t \sin (\omega t + 90^\circ) \\ &= \frac{U_m I_m}{2} \sin 2 \omega t = UI \sin 2 \omega t \end{aligned}$$

2.

$$\begin{aligned} P &= \frac{1}{T} \int_0^T p dt \\ &= \frac{1}{T} \int_0^T UI \sin (2 \omega t) dt = 0 \end{aligned}$$

C



$$p = i \cdot u = UI \sin 2 \omega t$$

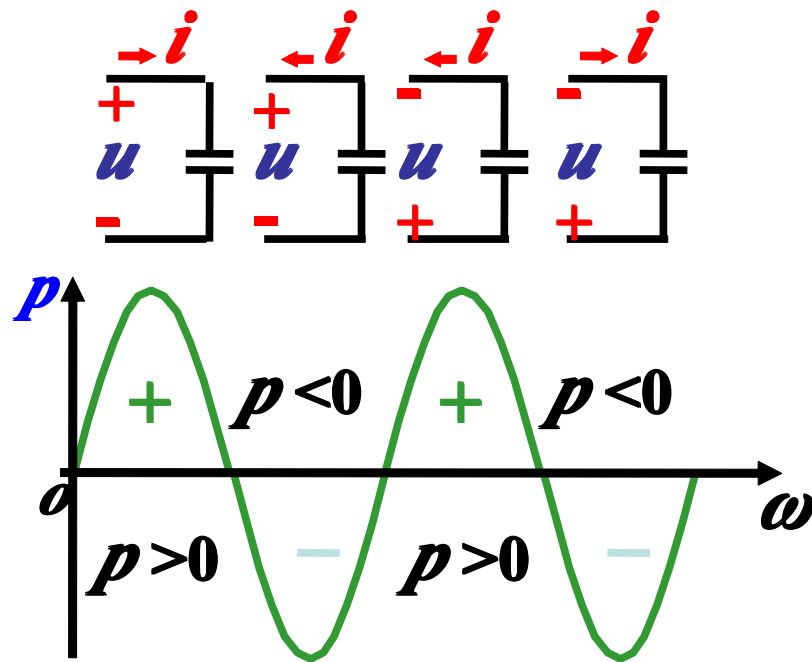



2011 11 1

4.5.4 RLC

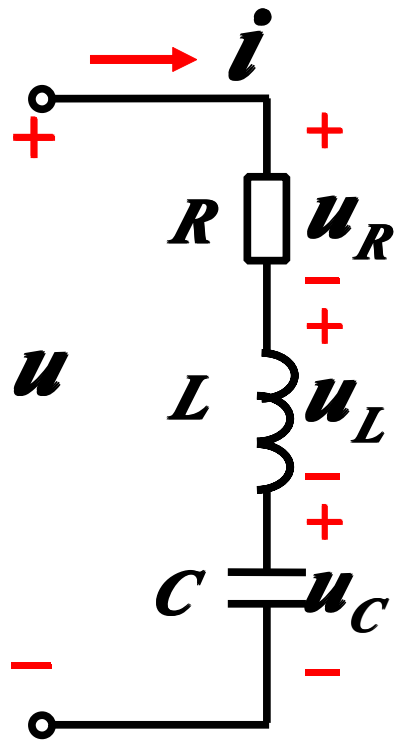

1.

$$i = I_m \sin \omega t$$

$$u = U_m \sin(\omega t + \varphi)$$

$$p = u \cdot i = U_m \sin(\omega t + \varphi) \cdot I_m \sin \omega t$$

$$= \underline{U_m I_m \cos \varphi \sin^2 \omega t} + \underline{U I \sin \varphi \sin 2\omega t}$$



2. P

$$P = \frac{1}{T} \int_0^T p dt$$

$$= \frac{1}{T} \int_0^T [UI \cos \phi - UI \cos(2\omega t + \phi)] dt$$

$$= UI \cos \phi \quad : W$$

$$P = UI \cos \phi$$

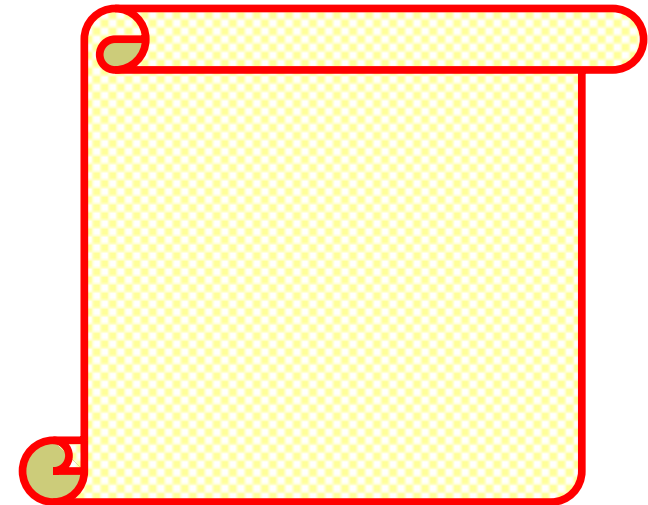
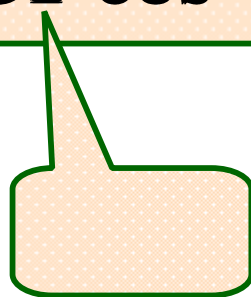
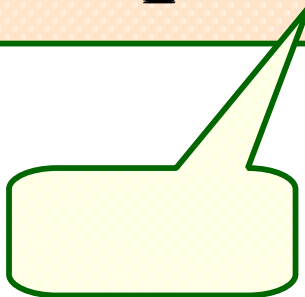



$$P = UI \cos \varphi = U_R I = I^2 R$$

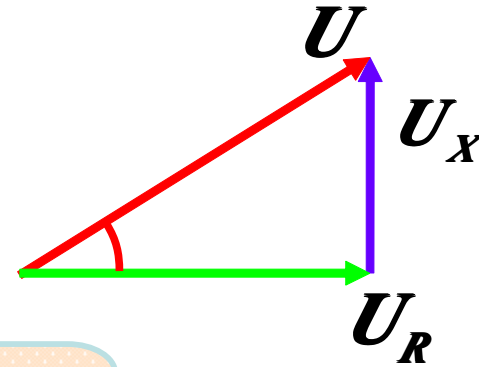

3. Q

$$Q = U_L I - U_C I = (U_L - U_C) I = I^2 (X_L - X_C)$$

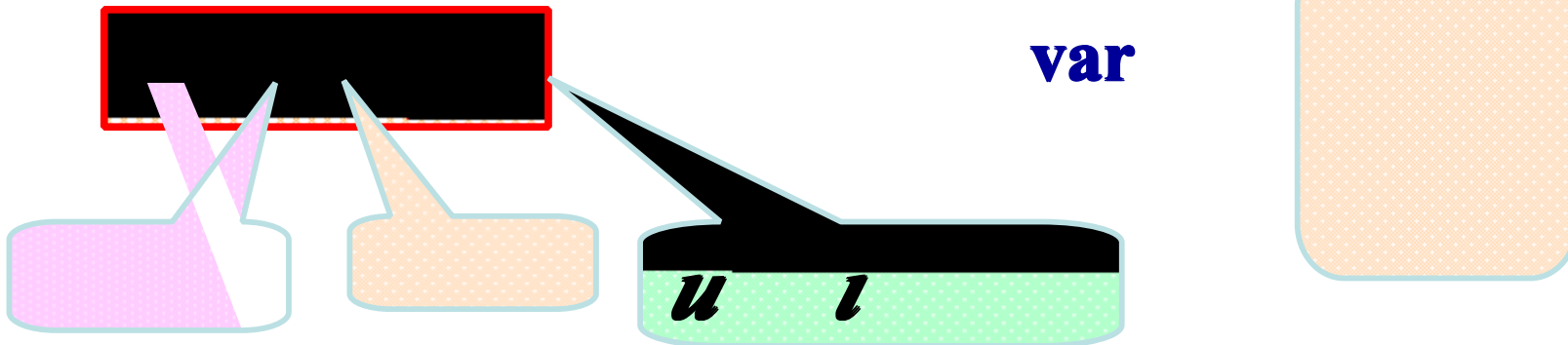



4.

S

$$S = UI = |Z|I^2$$

V·A

$$S_N = U_N I_N$$

$$S = \sqrt{P^2 + Q^2}$$

~~=~~ +

♣ *P Q S*



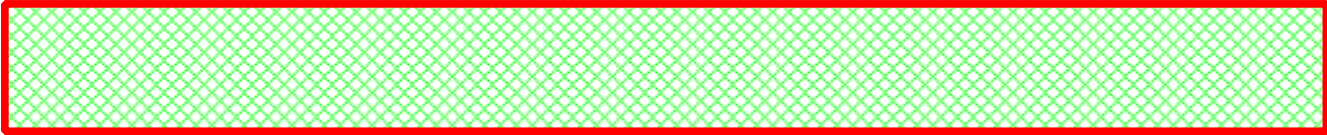

$$U = \sqrt{U_R^2 + (U_L - U_C)^2}$$

$$U_R = U \cos \varphi$$

$$U_X = U \sin \varphi$$

$$|Z| = \sqrt{R^2 + (X_L - X_C)^2}$$

$$R = |Z| \cos \varphi$$

$$X = |Z| \sin \varphi$$

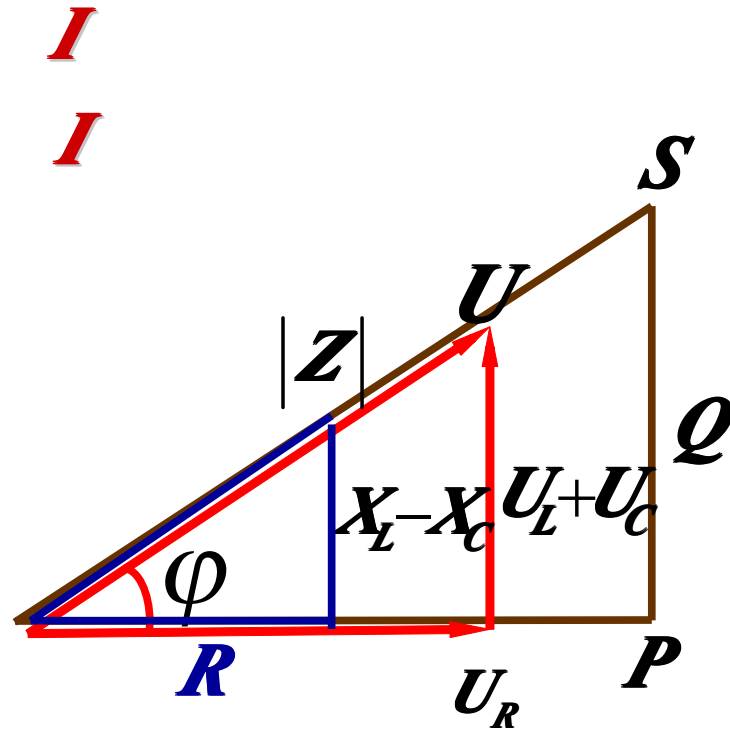

$$S = \sqrt{P^2 + Q^2}$$

$$P = S \cos \varphi$$

$$Q = S \sin \varphi$$



4.5.5

1. P

$$= \sum$$

$$P = \sum_1^i U I \cos \varphi$$

2. Q

$$U_i I_i$$

$$= \sum -$$

$$Q = \sum \sin \varphi$$

4.6



1.

φ :

φ

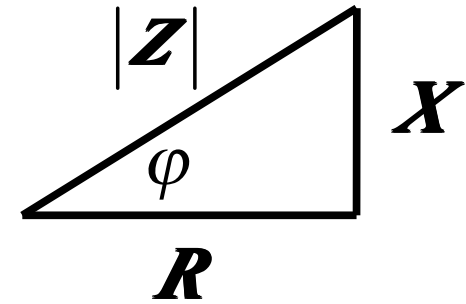
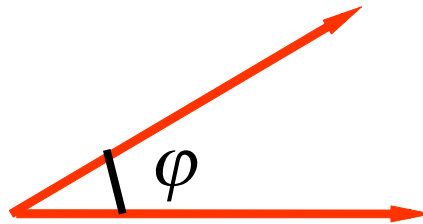
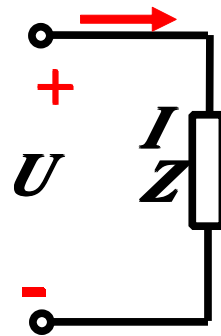

$$Z = R + jX$$

$$\cos \varphi < 1 ,$$

$$Q = UI \sin \varphi$$

,

:





(1)

$$S_N = U_N \cdot I_N = 1000 \text{ kV} \cdot \text{A}$$

$$\cos\varphi = 1$$

$$\cos\varphi = 0.6$$

j

z

zjz sin 800kvar

2



$$\begin{aligned} & \mathbf{r} : \\ : \mathbf{P} = \mathbf{U} \mathbf{I} \cos \varphi & (\quad) \\ \mathbf{I} = \frac{\mathbf{P}}{\mathbf{U} \cos \varphi} & \left\{ \begin{array}{l} \mathbf{I} \mathbf{r} (\quad) \end{array} \right. \end{aligned}$$

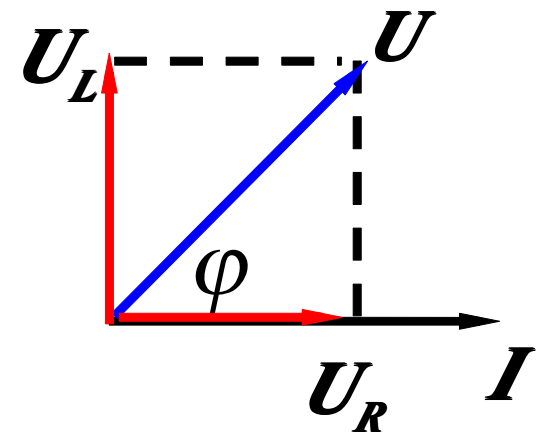
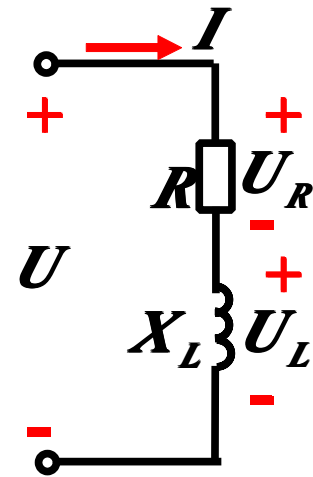



	$\cos\varphi = 1 \quad (\varphi = 0)$
	$\cos\varphi = 0 \quad (\varphi = \pm 90^\circ)$
<i>R-L-C</i>	$1 > \cos\varphi > 0$ $(-90^\circ < \varphi < +90^\circ)$
	$\cos\varphi = 0.2 \sim 0.3$ $\cos\varphi = 0.7 \sim 0.9$
<i>R-L</i>	$\cos\varphi = 0.5 \sim 0.6$



3.
(1)

(2)

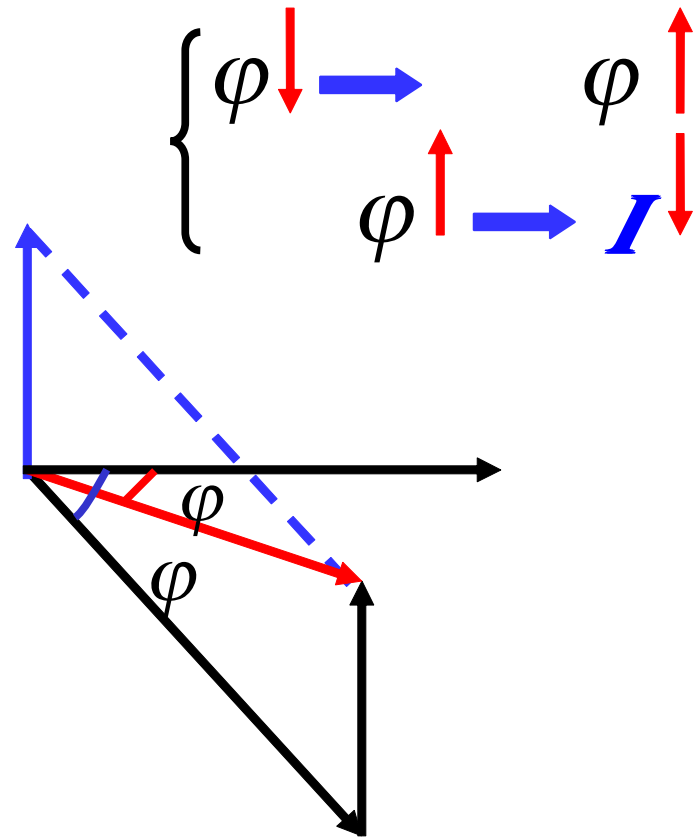
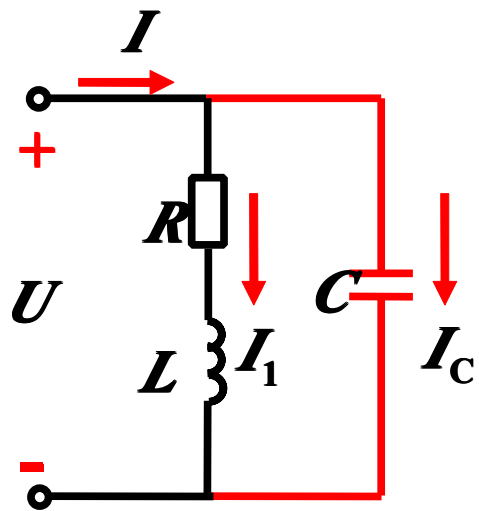

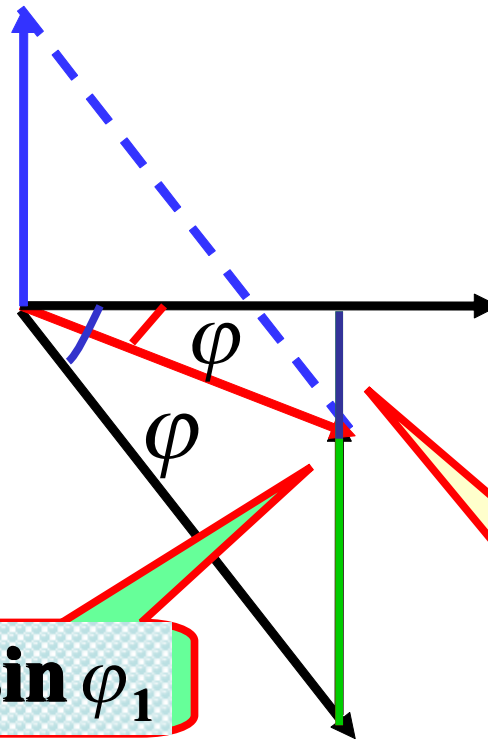
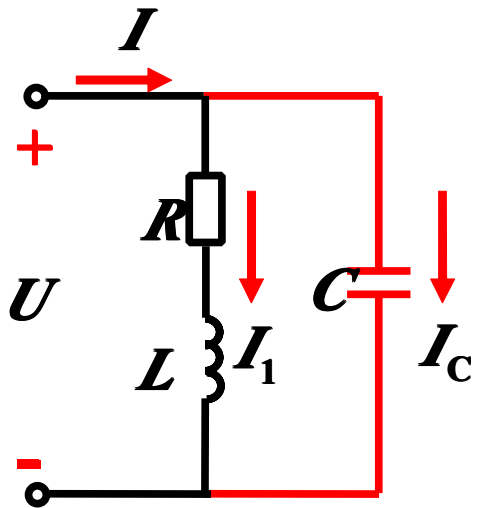

$$I_C = I_1 \sin \varphi_1 - I \sin \varphi$$

$$I_1 \sin \varphi_1$$

$$I \sin \varphi$$

$$\therefore U \omega C = I_1 \sin \varphi_1 - I \sin \varphi$$

$$U \omega C = \frac{P}{U \cos \varphi_1} \sin \varphi_1 - \frac{P}{U \cos \varphi} \sin \varphi$$

∴ , $P=10\text{kW}$, $\cos\varphi = 0.0$
 $U=220\text{V}$, $f=50\text{Hz}$

1 $\cos\varphi = 0.95$,
 C , C

2 $\cos\varphi = 0.95$ 1
 C

$$(1) C = \frac{P}{\omega U^2} (\tan \varphi_1 - \tan \varphi)$$

$\cos\varphi = 0.6$

$\cos\varphi$

$$C = \frac{P}{314 \cdot 220^2}$$



$$C : I_1 = \frac{P}{U \cos \varphi_1} = \frac{10 \cdot 10^3}{220 \cdot 0.6} \text{ A} = 75.6 \text{ A}$$

$$C : I = \frac{P}{U \cos \varphi} = \frac{10 \cdot 10^3}{220 \cdot 0.95} \text{ A} = 47.8 \text{ A}$$

$$(2) \cos \varphi = 0.95 \quad 1$$

$$C = \frac{10 \cdot 10^3}{314 \cdot 220^2} (\tan 18^\circ - \tan 0^\circ) \text{ F} = 213.6 \mu\text{F}$$

$$: \cos \varphi = 1$$

$$(\quad) \quad 1$$

4.7



,

,

,





L C

{

L C u i
L C u i

(
)

4.7.1.

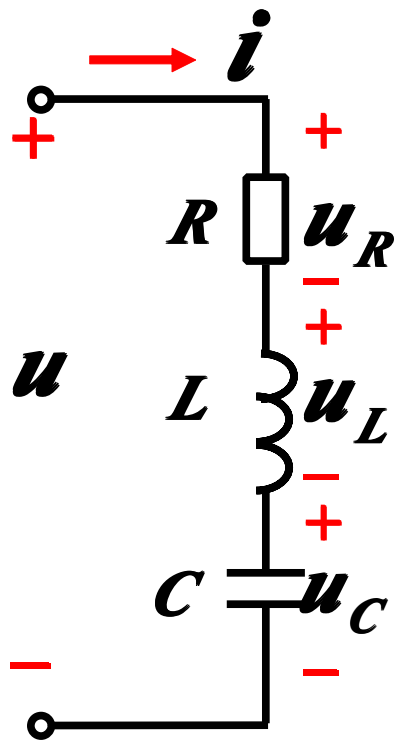

1.

$$\varphi = \arctan \frac{X_L - X_C}{R} = 0$$

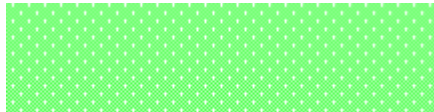

$$X_L = X_C$$

$$\omega_0 L = \frac{1}{\omega_0 C}$$



2.

$$\omega_0 L = \frac{1}{\omega_0 C}$$





2.

$$2\pi f_0 L = \frac{1}{2\pi f_0 C}$$

$$f_0 = \frac{1}{\sqrt{LC}}$$

$$f_0 = \frac{1}{2\sqrt{LC}}$$

$$\frac{f}{LC}$$

$$L C f_0 = f$$

$$f = f_0$$

3.

(1)

$$|Z| = \sqrt{R^2 + (X_L - X_C)^2} = R$$



(2)

$$I = I_0 = \frac{U}{R}$$

(3) U I $\varphi = \arctan \frac{X_L - X_C}{R} = 0$

$$Q_L \quad Q_C$$

(4)

$$U_R = I_0 R = U$$

$$U_L = -U_C$$

180

$$U_L = I_0 X_L = U_C = I_0 X_C$$

$$X_L = X_C \gg R$$

$$U_L = U_C \gg U_R = U$$

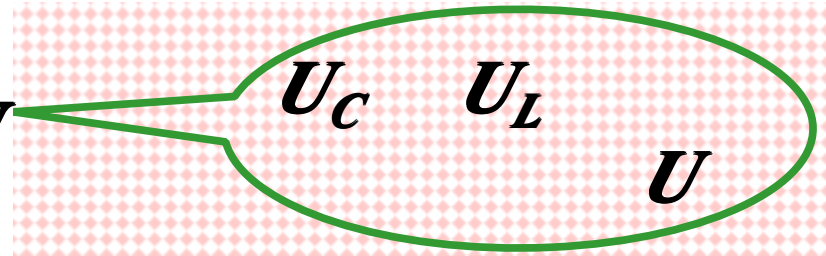

$$U_L = U_C \gg U$$

$$Q = \frac{U}{U} \frac{U_C}{U} \frac{L}{R} = \frac{L}{RC}$$

$$U_L = U_C = QU$$



$$: U_L \quad U_C$$

$$U_L = I_0 X_L = \frac{L}{R} U = QU$$

$$U_C = I_0 X_C = \frac{1}{CR} U = QU$$

$$Q=100, U=220V,$$

$$U_L = U_C = QU = 22000V$$

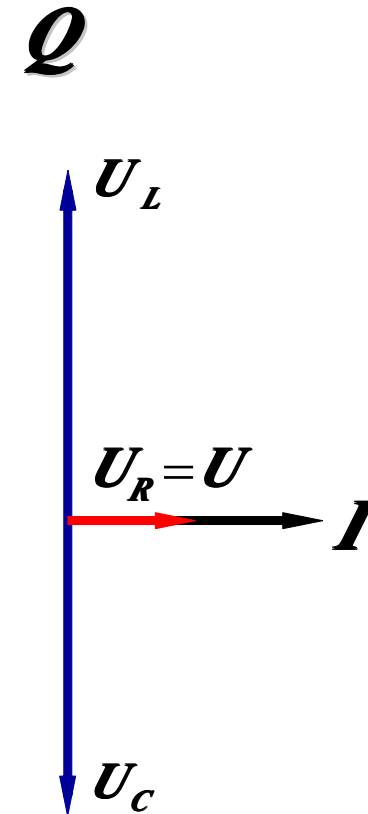



4.

(1)

$$X_L = fL$$

$$X_C = \frac{1}{fc}$$

$$Z = R + j(X_L - X_C)$$

$$|Z| = \sqrt{R^2 + \left(\frac{L - 1}{C} \right)^2}$$

{	$<$	0	$ Z $
	$=$	0	$ Z = R$
	$>$	0	$ Z $

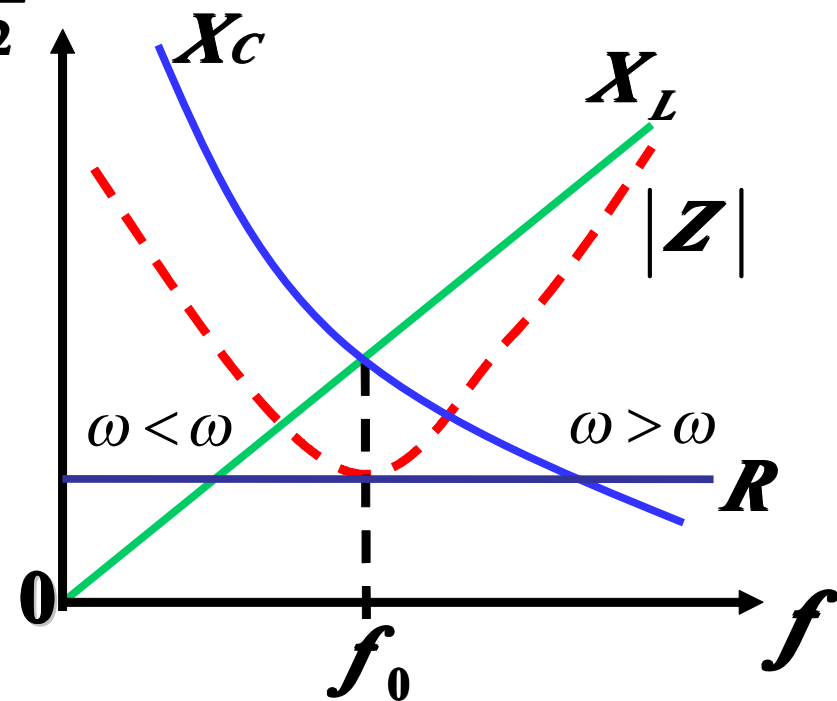

(2)



$$I(f) = \frac{U}{|Z|} = \frac{U}{\sqrt{R^2 + (\omega L - 1/\omega C)^2}}$$

$$I_0 = \frac{U}{R}$$

$R \downarrow$

$$\left\{ \begin{array}{l} I_0 \\ Q \end{array} \right. = \frac{U L}{R}$$

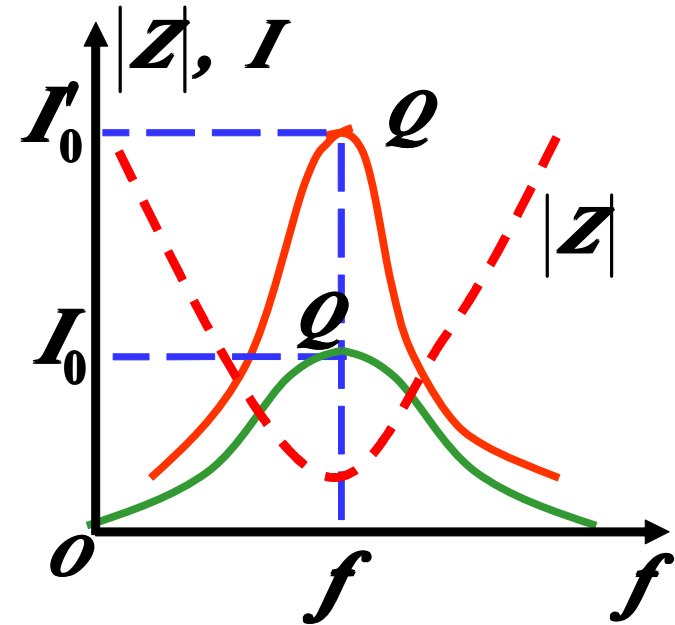

Q



$$0.707I_0$$
$$f = f_2 \quad f_1$$

f_0
 f_1
 f_2

(Q)

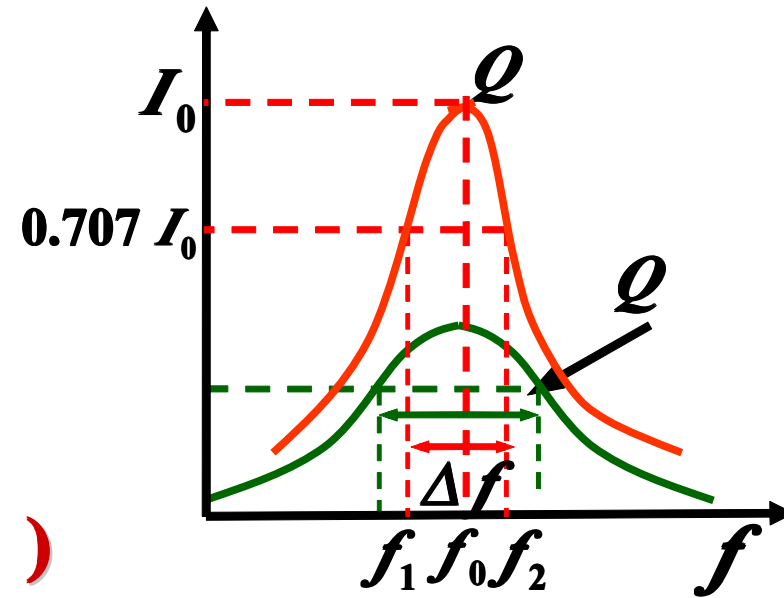

5.

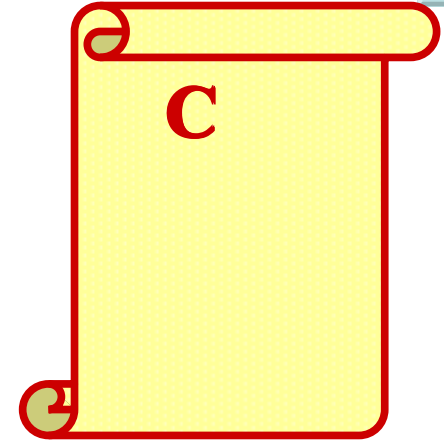
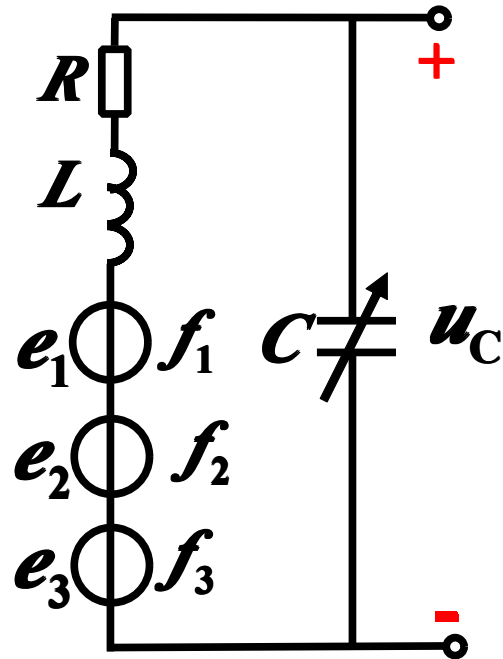
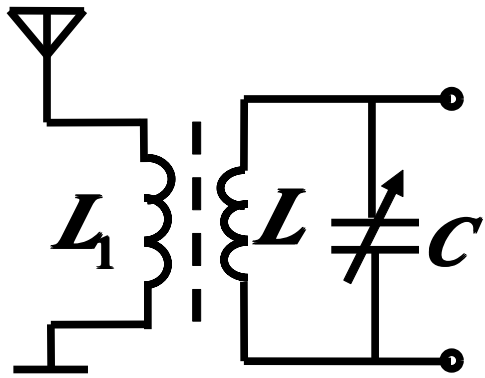

$\left\{ \begin{array}{l} L_1 \\ LC \end{array} \right.$

$$I_0 = I_{\max} \Rightarrow$$

$$U_C = QU$$

$e_1 \quad e_2 \quad e_3$

3

()

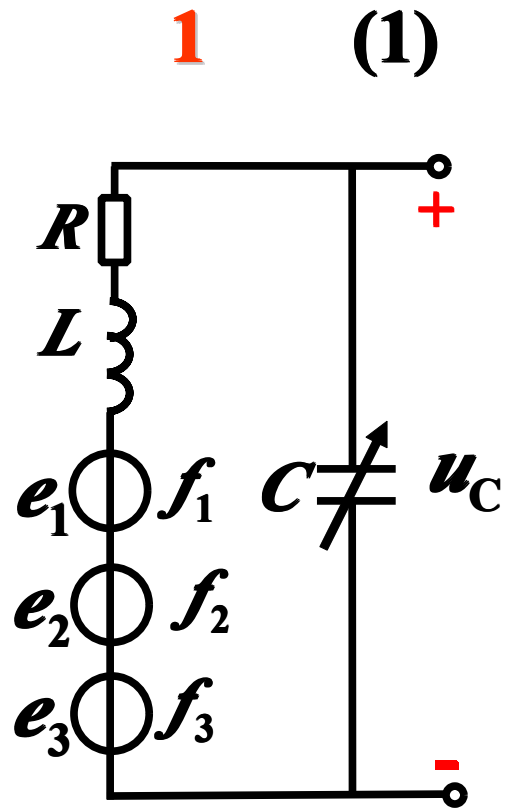

e_1 C

$L = 0.3\text{mH}$ $R = 16\Omega$

$f_1 = 640\text{kHz}$

$$f_0 = f_1 = \frac{1}{2\pi\sqrt{LC}}$$

$$C = \frac{1}{(2\pi f_0)^2 L}$$

$$C = \frac{1}{(2\pi \cdot 640 \cdot 10^3)^2 \cdot 0.3 \cdot 10^{-3}} = 204\text{pF}$$

C **204 pF** e_1

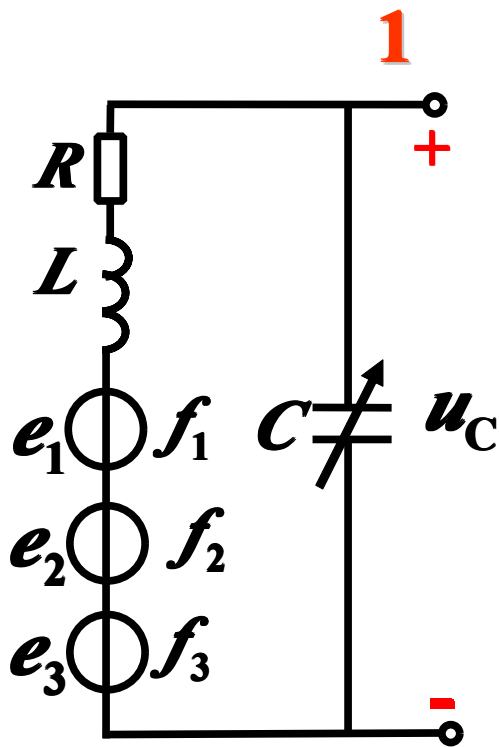

$$C$$
$$E_1 = 2 \mu\text{V}$$

$$f_1 = 640\text{kHz}$$

$$I = E_1 / 16 = 0.13 \mu\text{A}$$

$$X_L = X_C = \omega L = 2\pi f_1 L = 1200 \Omega$$

$$U_{C1} = IX_C = 156 \mu\text{V} \quad Q = \frac{U_{C1}}{E_1} = \frac{156}{2} = 78$$

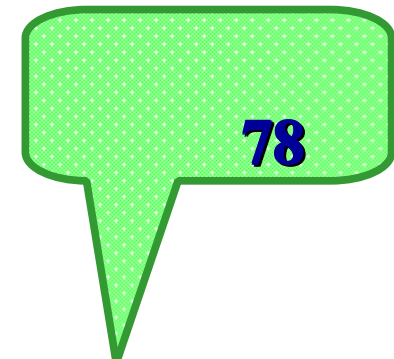



4.7.2

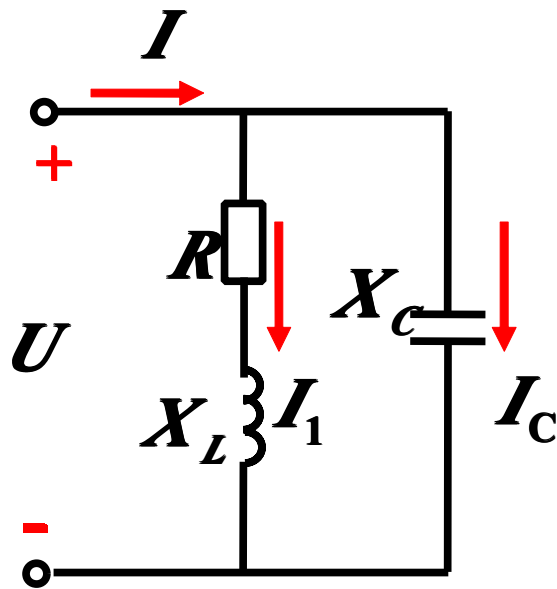

1.

$$\begin{aligned} Z &= \frac{1}{j\omega C} \frac{(R + j\omega L)}{\frac{1}{j\omega C} + (R + j\omega L)} \\ &= \frac{R + j\omega L}{1 + j\omega RC - \omega^2 LC} \end{aligned}$$

$$Z = \frac{j\omega L}{1 - \omega^2 LC + j\omega RC} = \frac{1}{\frac{RC}{L} + j\omega C - \frac{1}{\omega L}} \quad \omega_0 L \gg R$$



1.

$$Z = \frac{j\omega L}{1 - \omega^2 LC + j\omega RC} = \frac{1}{\cancel{RC}/L + j(\omega C - \cancel{1}/\omega L)}$$

$$\omega_0 C - \frac{1}{\omega_0 L} \approx 0$$

2.

$$\omega_0 \approx \frac{1}{\sqrt{LC}}$$

$$f = f_0 = \frac{1}{2\sqrt{LC}}$$

3.

(1)

$$|Z_0| = \frac{L}{RC}$$

($\omega_0 L \gg R$)



(2)

$$I = I = \frac{U}{L/RC} = \frac{U}{|Z|}$$

$$U = I_s |Z_0|$$

(3)

$$I_1 = \frac{U}{\sqrt{R^2 + (2\pi f_0 L)^2}} \approx \frac{U}{2\pi f_0 L} \quad \text{for } \omega L \gg R$$

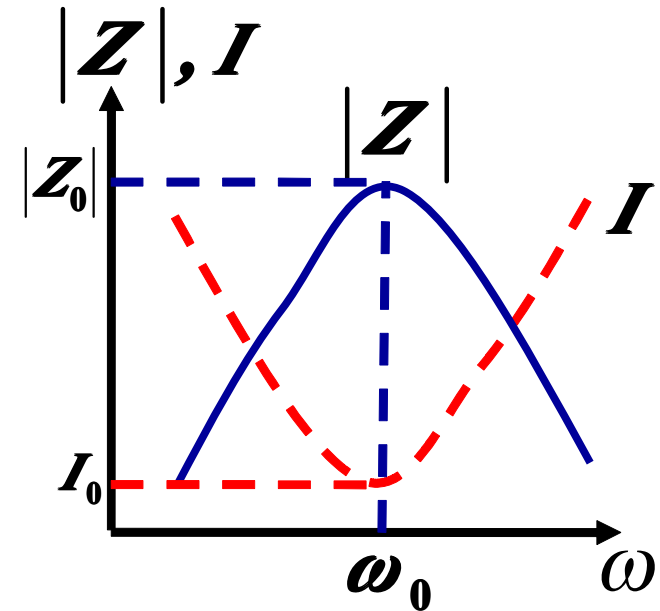



$$I_C = \frac{U}{\frac{1}{2\pi f_0 C}} = U \cdot 2\pi f_0 C$$

$$\frac{I_C}{I_0} = \frac{U(2f_0 C)}{U/|Z_0|} = \frac{U(2f_0 C)}{U/\frac{L}{RC}}$$

$$= \frac{2f_0 L}{R} = \frac{L}{R} = Q$$

$$\therefore I_1 \quad I_C = QI_0$$

Q

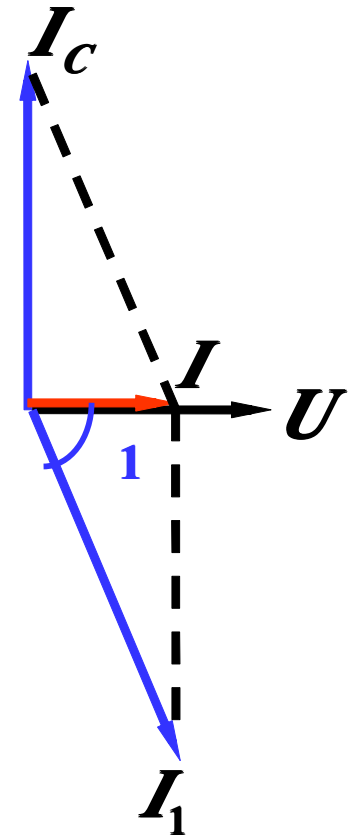



2

$$R=10\ \Omega \quad I_C=1\text{A} \quad \varphi_1=45^\circ$$

U, I_1

$$f=50\text{Hz}$$

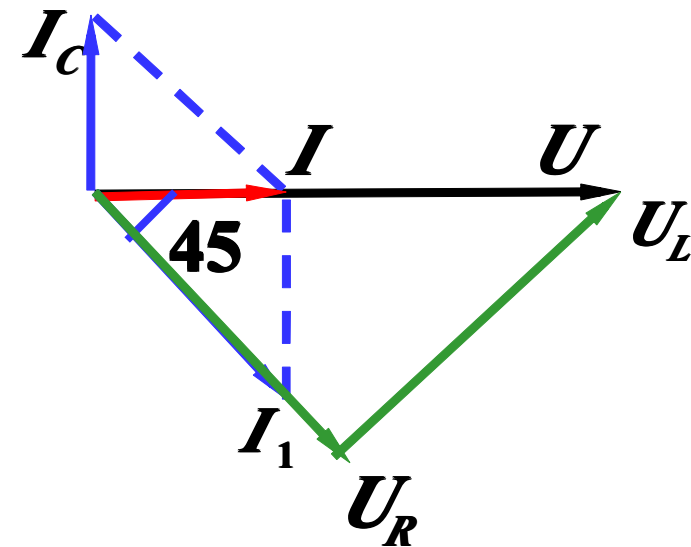
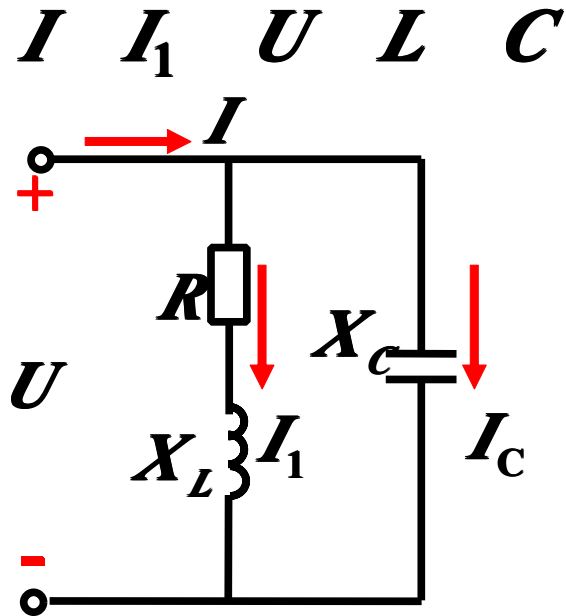

:

$$I_1 \sin \varphi_1 = I_C \quad I_C = 1\text{A}$$



