

# 电力系统电气部分设计

## 实验指导书

山东理工大学

电气与电子工程学院

2015. 3

## 实验一 具有事故灯光控制的断路器控制回路实验

### 4.1.1 实验目的

- (1)
- (2)

### 4.1.2 实验原理及实验说明

#### 4.1.2.1 具有事故灯光控制的断路器控制回路的实验原理

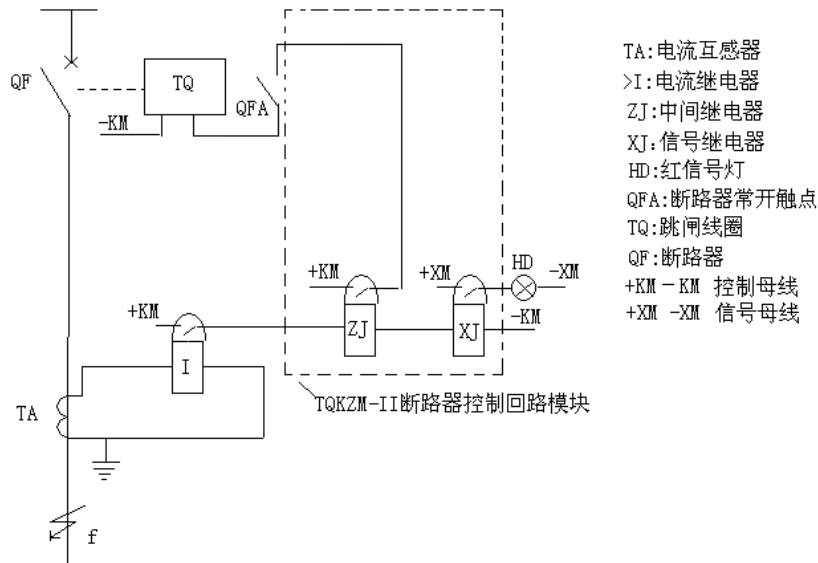
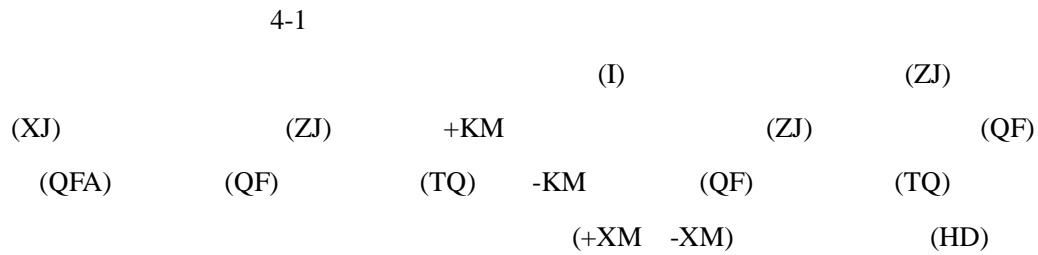

4-1

#### 4.1.2.2 TQKZM-II 型断路器控制回路模块简介及工作原理

- (1) TQKZM-II
- TQKZM-II

4-2

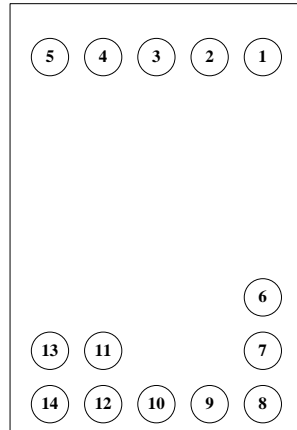

4-2 TQKZM-II

1		+KM		
2		TZ	TZ	10 TQ
3		HZ	HZ	9 HQ
4			BS	
5			+KM	
6	7			
8			-KM	
9		HQ		HQ
10		TQ		TQ
11	13			3 HZ
				5
12	14			4 TZ
				5

(2) TQKZM-II

TQKZM-II

4-3

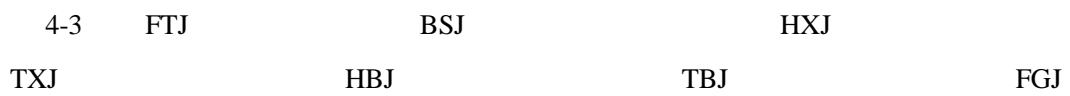

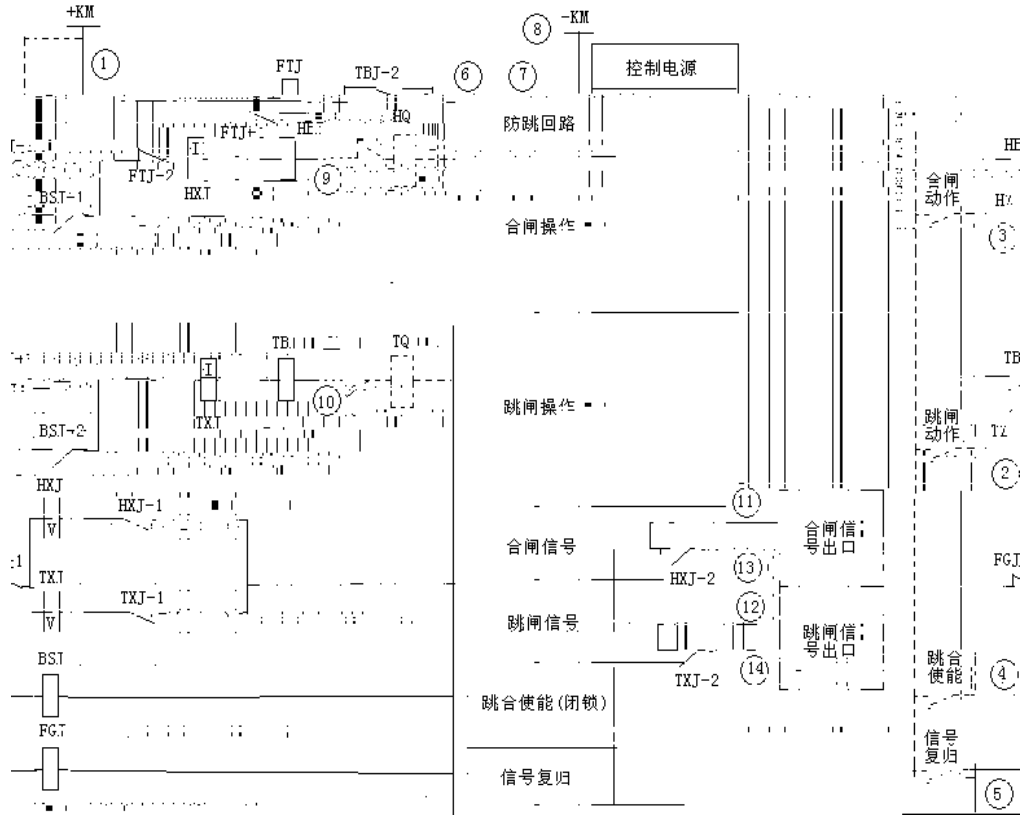

4-3 TQKZM-II

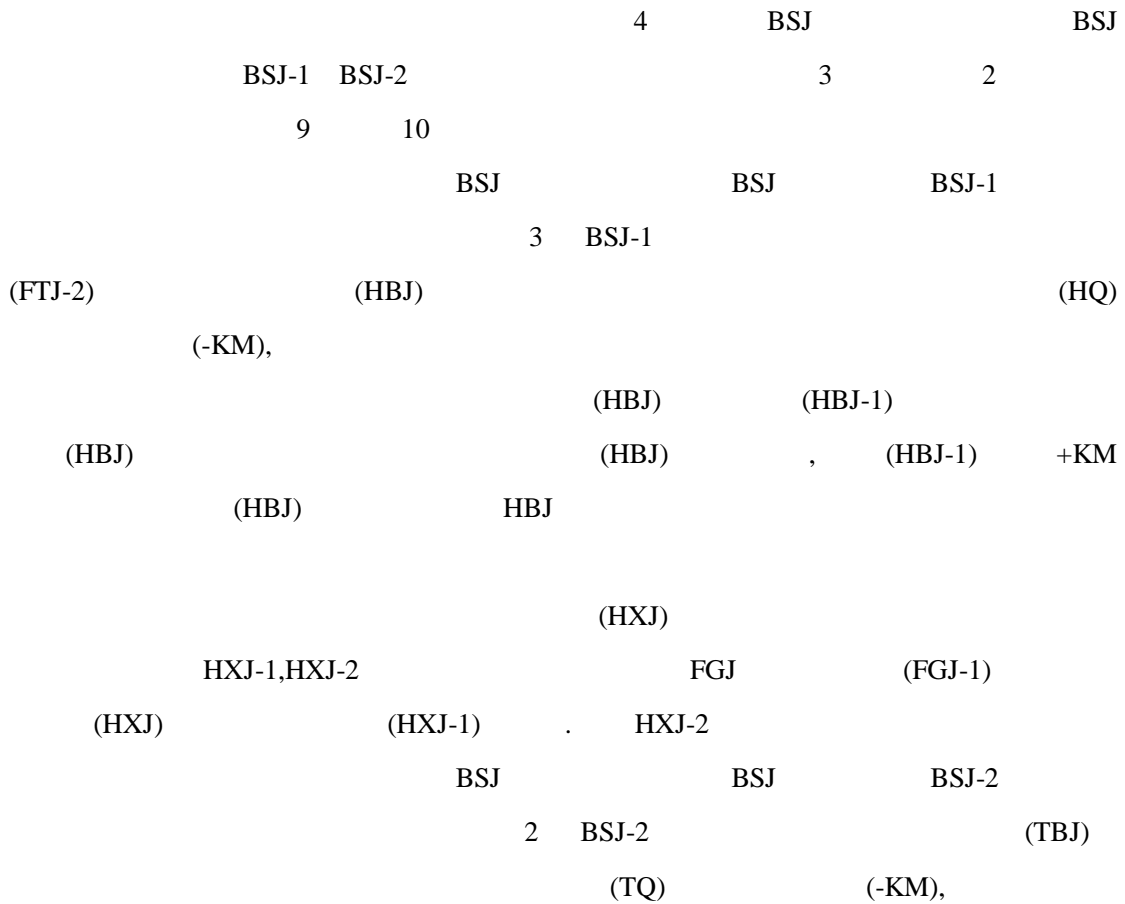

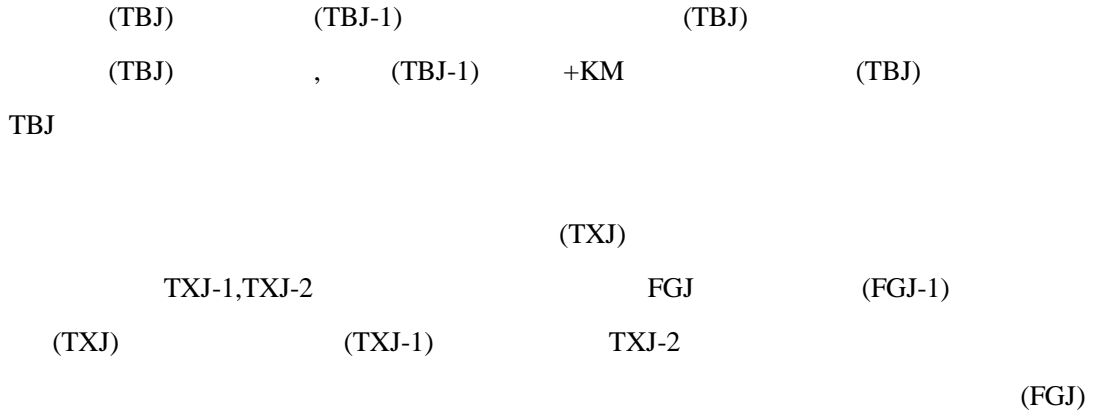

4. 1. 2. 3 断路器控制回路实验说明

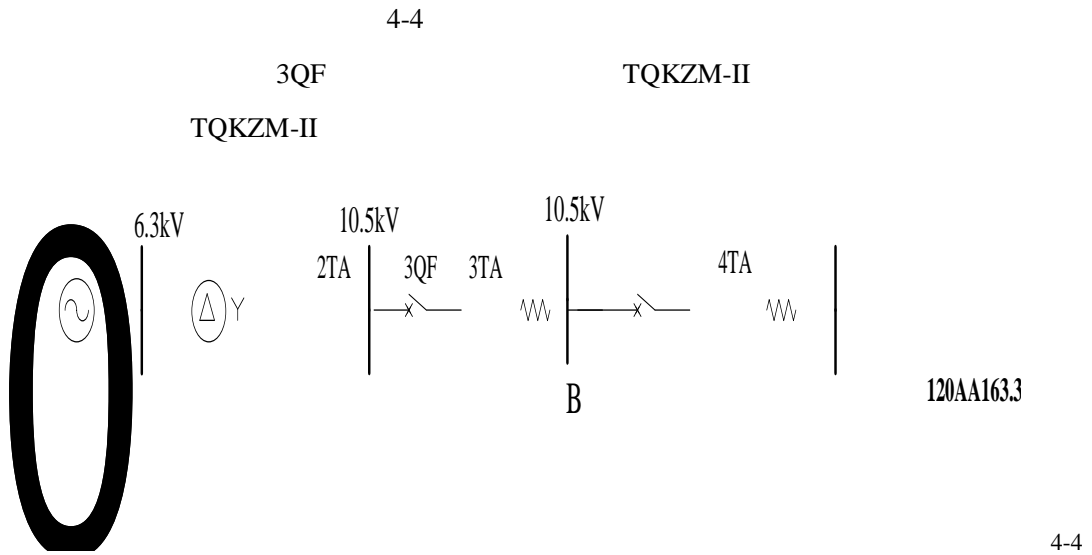

4. 1. 3 实验内容

4. 1. 3. 1 实验接线

- 4-5
- 1)
 

	(3QF)	2TA	Ia In	I In
--	-------	-----	-------	------
  - 2)

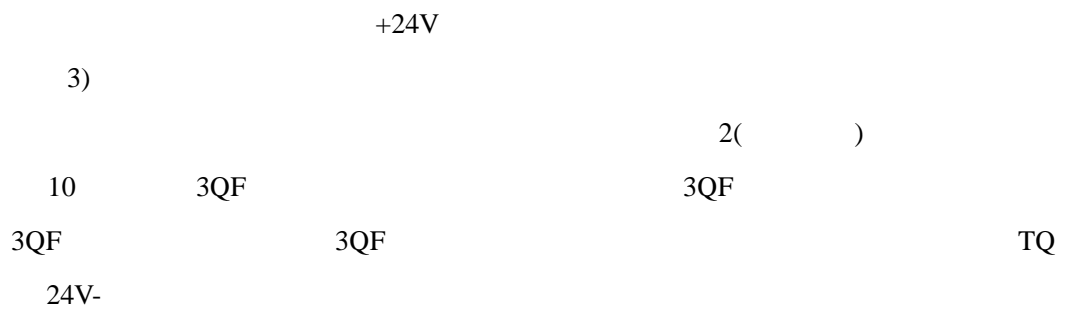

	+KM	KM	24V+	24V-
6)				
24V+				12
	A	K	24V-	14
7)				
			5	
24V+				

## 实验二 具有防跳功能的断路器控制回路实验

### 4.2.1 实验目的

- (1)
- (2)

### 4.2.2 实验原理及实验说明

#### 4.2.2.1 实验原理

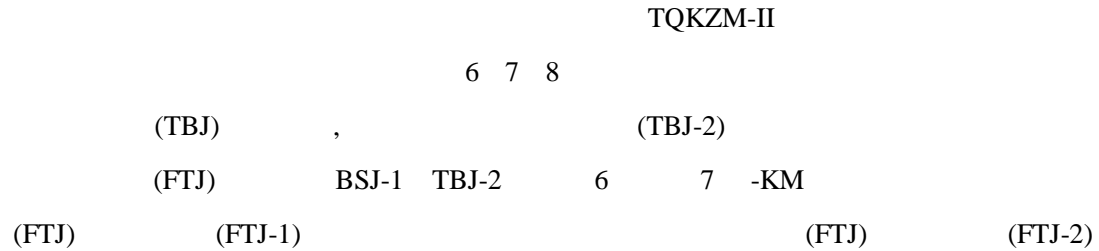

#### 4.2.2.2 实验说明

4.1

### 4.2.3 实验内容

#### 4.2.3.1 实验接线

4-6

1)

(3QF)

3TA

Ia In

I In

2)



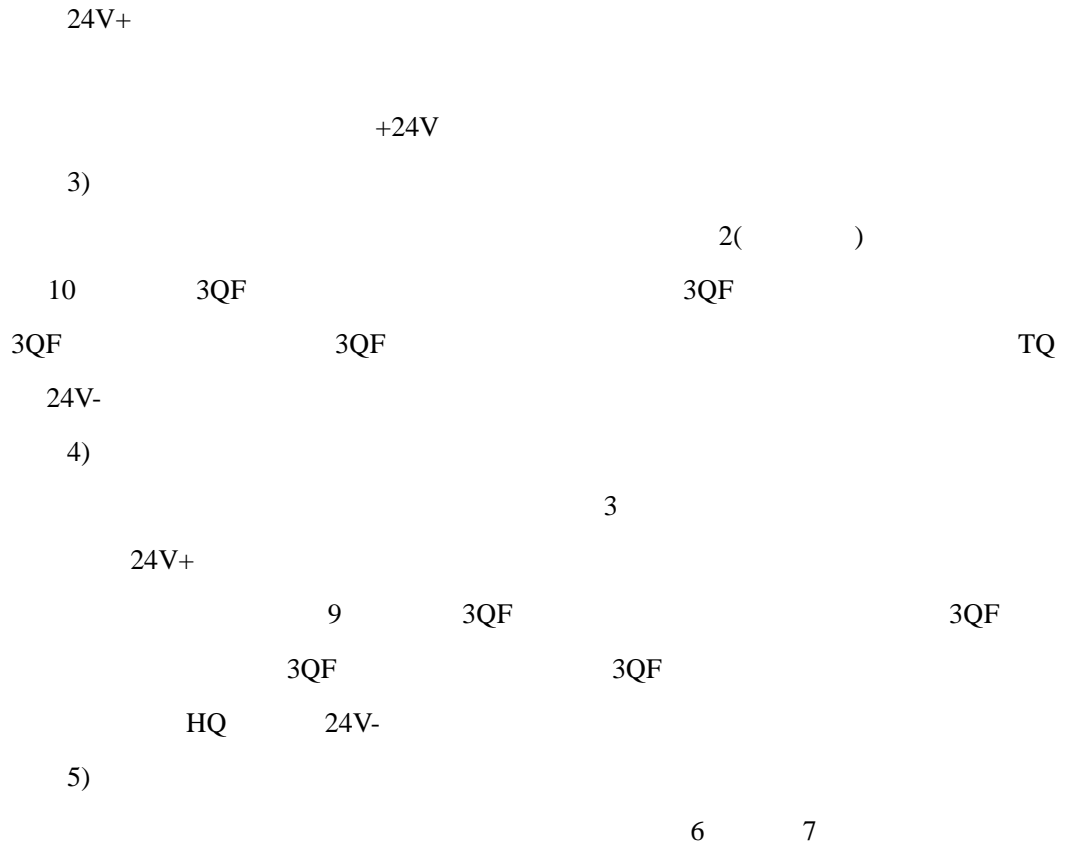

TQ

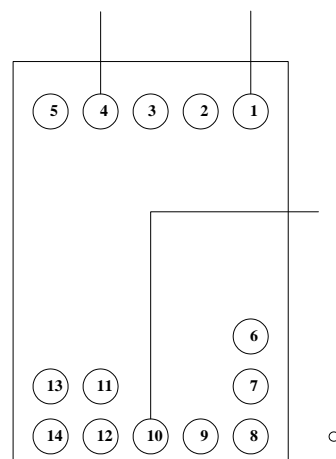

4-

(2)

(4)

a.

b.                    3QF                    2

(5)

(6)    6            7

(7)                    3 4

(8)                    KM    4

3 4

#### 4.2.4 思考题

(1)    ?

(2)    ?

(3)    ?

### 实验三 闪光继电器构成的中央信号实验

#### 4.3.1 实验目的

- (1)
- (2)
- (3)

#### 4.3.2 实验原理及实验说明

##### 4.3.2.1 实验原理

LW2

4-7

SA

SM

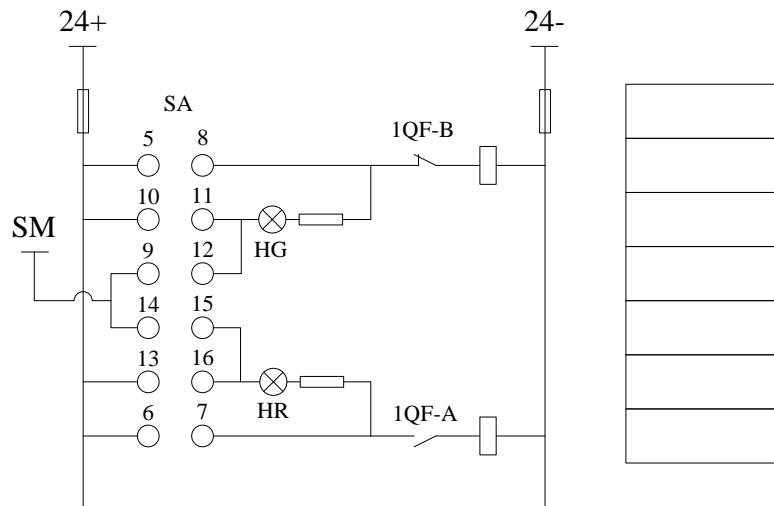

4-7

##### 4.3.2.2 实验说明

SA

4-1

4-1 SA

SA	
	5-8
	10-11
	9-12
	14-15
	13-16
	6-7

SA SA 90  
14 15 3QF-A

SA 45 6 7  
3QF-A 3QF-B  
SA 11 10 HG

SA 90 HG SA 10 11  
12 9 HG

SA 45 9 12 5 8  
3QF-B 3QF-B  
3QF-A

2 T Q F

## 4-2

1	JX-3/1	1
2	SM	1

## 实验四 冲击继电器构成的中央音响信号实验

### 4.4.1 实验目的

- (1) JC-2
- (2)

### 4.4.2 实验说明

#### 4.4.2.1 原理说明

JC-2

JC-2

#### 4.4.2.2 实验设备

4-3

4-3

1	JC-2	1
2		2
3		1
4		1
5	DL-31	1
6	DZY-202	1

### 4.4.3 实验内容

#### 4.4.3.1 实验接线

4-9

1)

(3QF)

3TA

Ia In

I In

2)

24V+

2( )

10 3QF

3QF

3QF

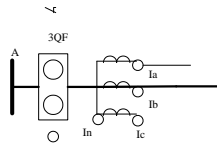

TQ

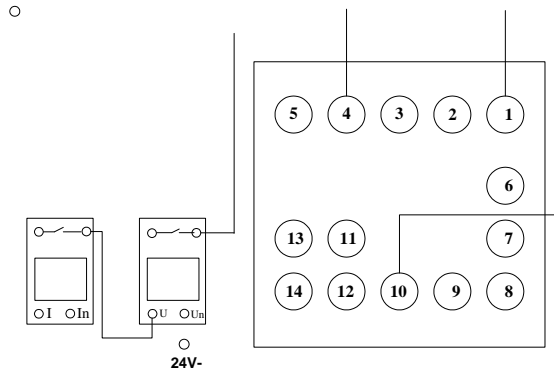

4-9

3)

12 14

4)

(1) 4A

(2)

(4)

(5) 2

(6) 5 24V+ 1

(7) 5 1

(8) 3~6

#### 4.4.4 思考题

1)

2)