

1.

2.

3.

VCR

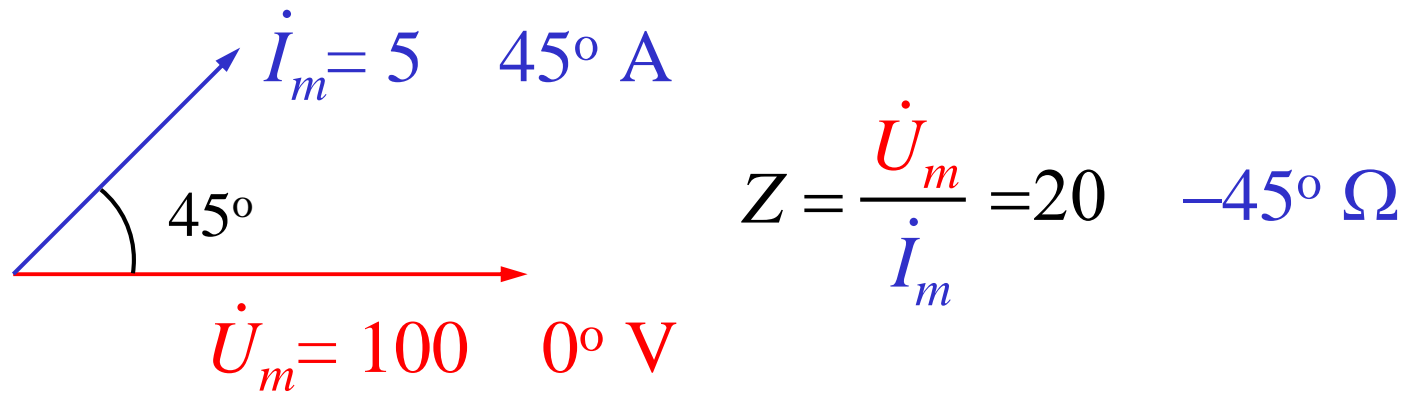

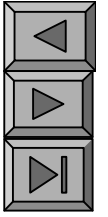

§ 8-1

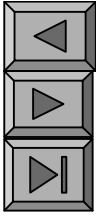

1.

$$(1) \quad F = a + jb$$

$$\operatorname{Re}[F] = a \quad \operatorname{Im}[F] = b$$

(2)

$$F = |F|(\cos\theta + j\sin\theta)$$

$$a = |F|\cos\theta \quad b = |F|\sin\theta$$

$$|F| = \sqrt{a^2 + b^2}$$

$$\theta = \operatorname{arctg} \frac{b}{a}$$

(3)

$$e^{j\theta} = \cos\theta + j\sin\theta$$

$$F = |F|e^{j\theta}$$

$$F = |F| \underline{\angle \theta}$$



(4)

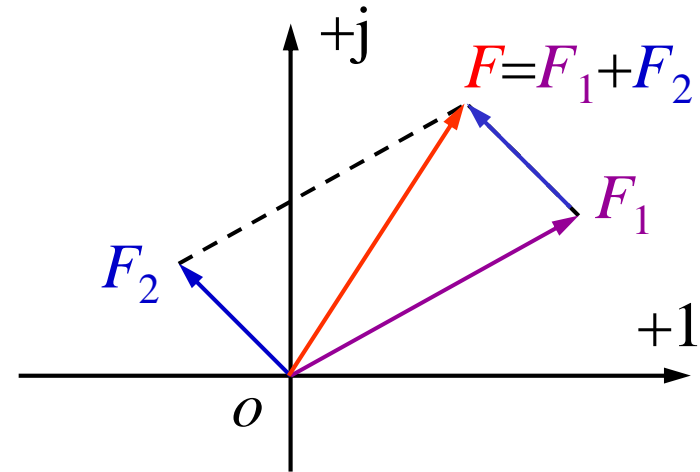
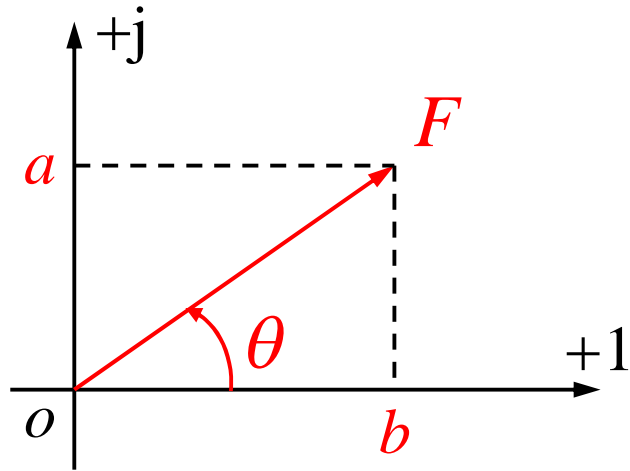

2.

(1)

$$F_1 = a_1 + j b_1 \quad F_2 = a_2 + j b_2$$

$$F_1 \pm F_2 = (a_1 \pm a_2) + j (b_1 \pm b_2)$$

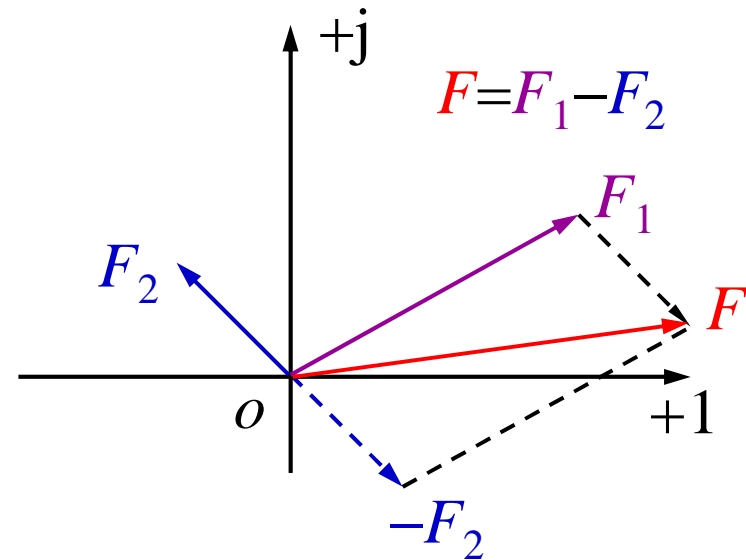

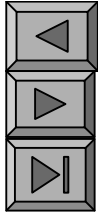

(2)

$$F_1 = |F_1| e^{j\theta_1} \quad F_2 = |F_2| e^{j\theta_2}$$

$$F = F_1 F_2 = |F_1| |F_2| e^{j(\theta_1 + \theta_2)}$$

$$F = |F_1| |F_2| \underline{\theta_1 + \theta_2} \quad F = \frac{F_1}{F_2} = \frac{|F_1|}{|F_2|} \underline{\theta_1 - \theta_2}$$

()

()

()



$$F_1 = F_2$$

$$|F_1| = |F_2| \quad \theta_1 = \theta_2$$

$$a_1 = a_2 \quad jb_1 = jb_2$$

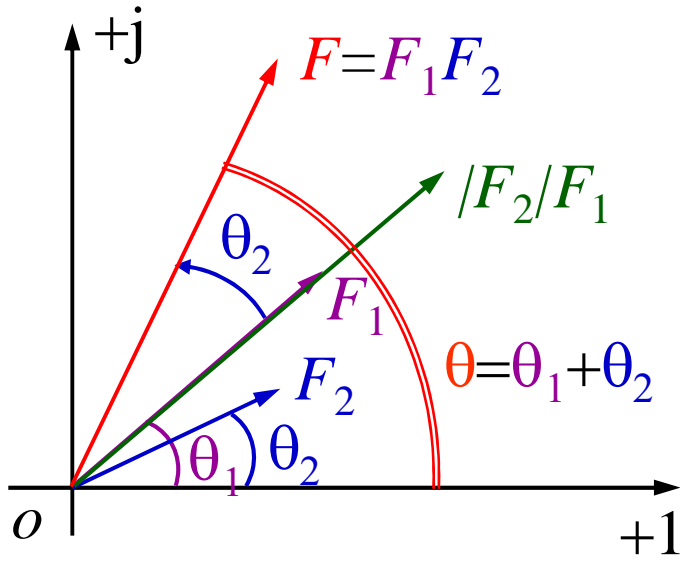
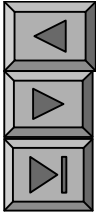

F_1
 $|F_2|$
 θ_2

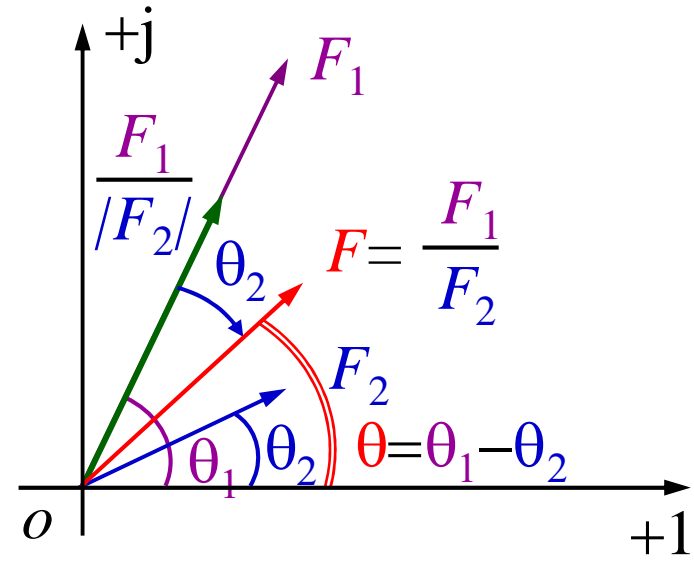

F_1
 $|F_2|$
 θ_2

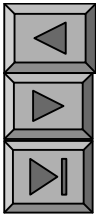

3.



$$e^{j\theta} = 1 \quad \theta$$

$$A = |A| e^{j\theta}$$

$$|A|$$

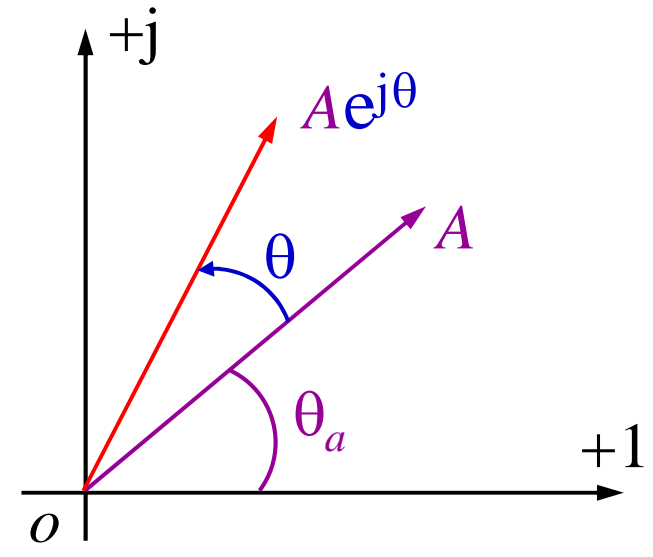

$$\left. \begin{aligned} e^{j\frac{\pi}{2}} &= j \\ e^{-j\frac{\pi}{2}} &= -j \\ e^{j\pi} &= -1 \end{aligned} \right\}$$

$$A \times j = jA \quad 90^\circ$$

$$\frac{A}{j} = -jA \quad 90^\circ$$

§ 8-2

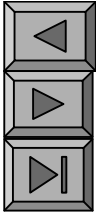

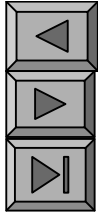

$$i = I_m \cos(\omega t + \phi_i)$$

$$i = I_m \sin(\omega t + \phi_i)$$

$$i = I_m \cos(\omega t + \phi_i) \quad u = U_m \cos(\omega t + \phi_u)$$

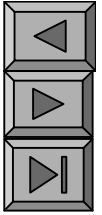

1.

$$i = I_m \cos(\omega t + \phi_i) = \sqrt{2} I \cos(\omega t + \phi_i)$$

(1) I_m I ()

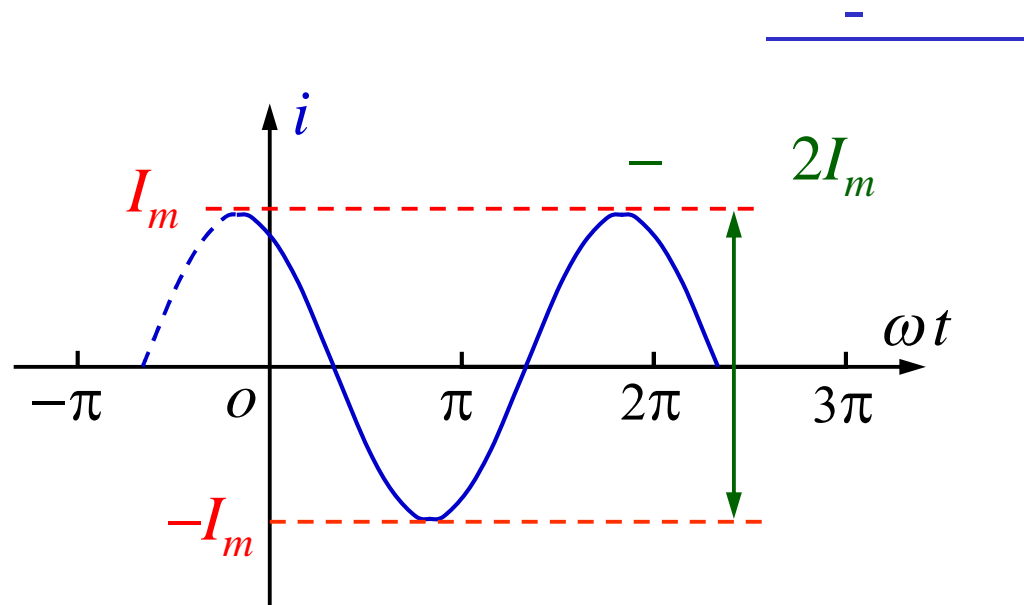

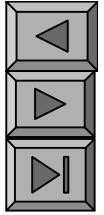

$$I^2 R T = \int_0^T i^2 R dt \longrightarrow I \stackrel{\text{def}}{=} \sqrt{\frac{1}{T} \int_0^T i^2 dt}$$

$$i = I_m \cos(\omega t + \psi_i)$$

$$I_m = \sqrt{2} I$$

$$U_m = \sqrt{2} U$$

$$U = 220\text{V}$$

$$U_m = 311\text{V}$$

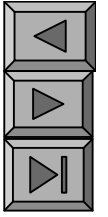

$I \quad U$

$i \quad u$

$I_m \quad U_m$
 $I_M(I_{\max})$

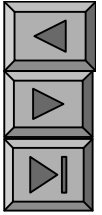

(2) ω f T ()



$$\omega = \frac{d}{dt} (\omega t + \phi_i)$$

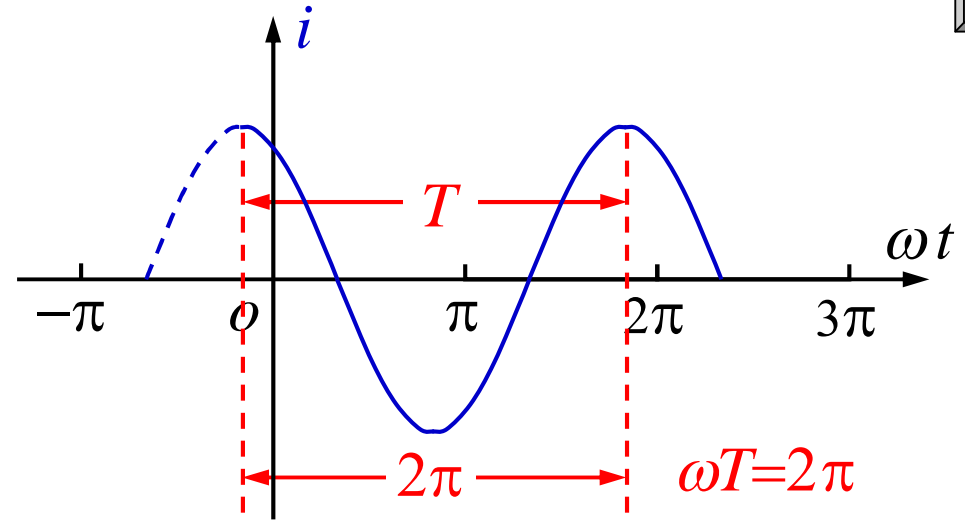

f



T

Hz

ω f T

$$\omega = 2\pi f \quad f = \frac{1}{T} \quad T = \frac{1}{f}$$

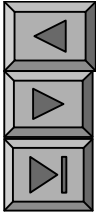

(3)

ϕ_i ()

$(\omega t + \phi_i)$

, :

rad (°)

$t=0$

ϕ_i

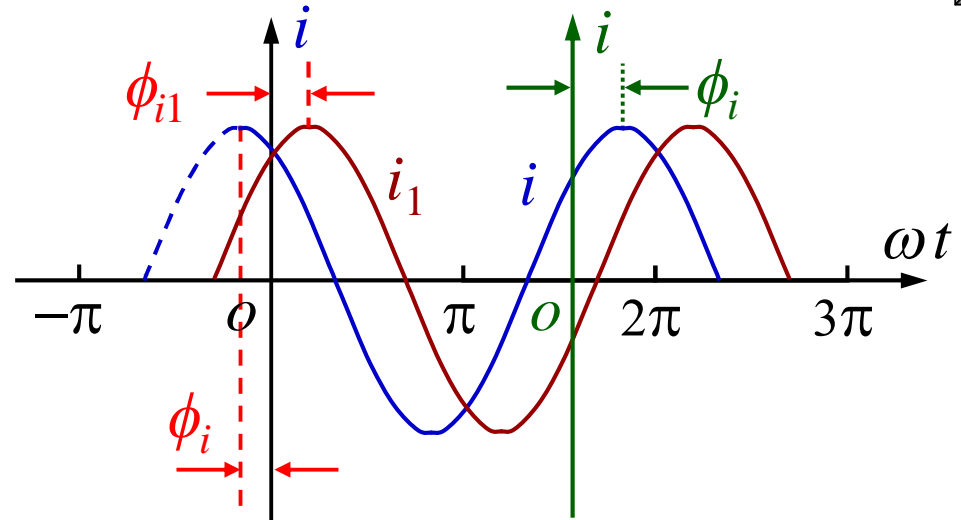

$|\phi_i| \leq 180^\circ$

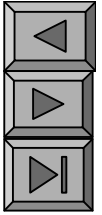

2.

$$i_1 = I_m \cos(\omega t + \phi_{i1}) \quad u_2 = U_m \cos(\omega t + \phi_{u2})$$



ϕ_{12}

$$\phi_{12} = (\omega t + \phi_{i1}) - (\omega t + \phi_{u2}) = \phi_{i1} - \phi_{u2}$$

(1) $\phi_{12} = 0$ i u
 u i i u

(2) $\phi_{12} = 0$ u i
 i u u i

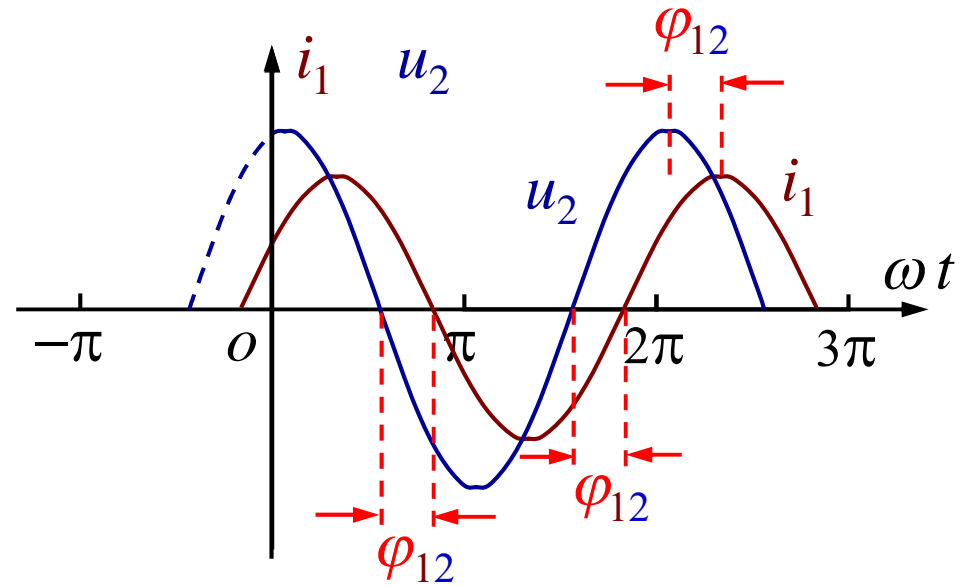

$$\phi_{12} = |\pi|$$

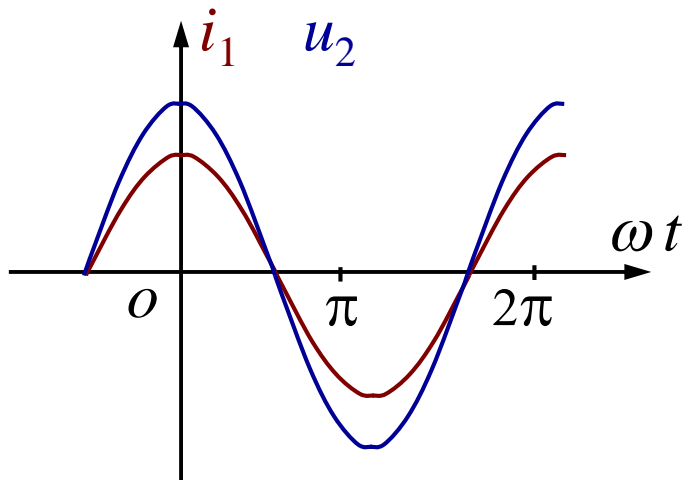

$\varphi_{12}=0$ i_1 u_2

$\varphi_{12}=180^\circ$ i_1 u_2

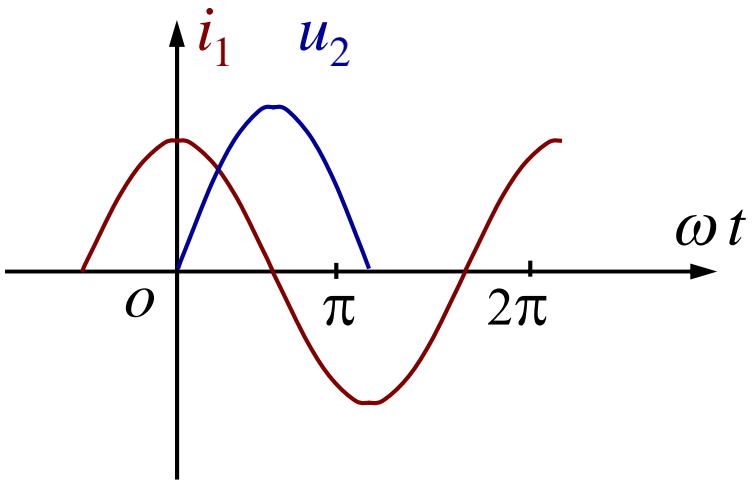
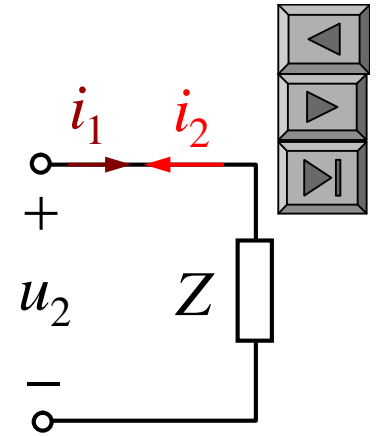

$\varphi_{12}=90^\circ$ i_1 u_2

§ 8-3

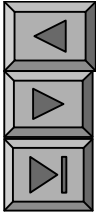

() () _____
KCL KVL

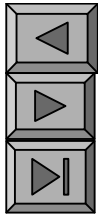

1.

$$: e^{j\theta} = \cos\theta + j\sin\theta$$

$$\theta = \omega t + \phi_i \quad e^{j(\omega t + \phi_i)} = \cos(\omega t + \phi_i) + j\sin(\omega t + \phi_i)$$

$$i = I_m \cos(\omega t + \phi_i)$$

$$i = \operatorname{Re}[I_m e^{j(\omega t + \phi_i)}] = \operatorname{Re}[\underline{I_m} e^{j\phi_i} e^{j\omega t}]$$

$$= \operatorname{Re}[\dot{I}_m e^{j\omega t}]$$

$$\dot{I}_m = I_m e^{j\phi_i}$$

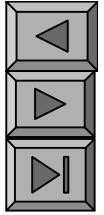

$$i = I_m \cos(\omega t + \phi_i)$$

$$\dot{I}_m = I_m e^{j\phi_i}$$

$$\dot{I}_m = I_m \underline{\phi_i}$$

$$\dot{U}_m = 300 \underline{30^\circ} \text{ V}$$

$$u = 300 \cos(\omega t + \phi_u)$$

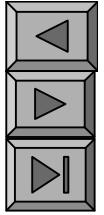

$$\dot{I}_m = I_m \angle \phi_i$$

$$[I_m e^{j\phi_i} e^{j\omega t}]$$

$$i = I_m \cos(\omega t + \phi_i)$$

$$[I_m e^{j\phi_i} e^{j\omega t}]$$

$$e^{j\omega t}$$

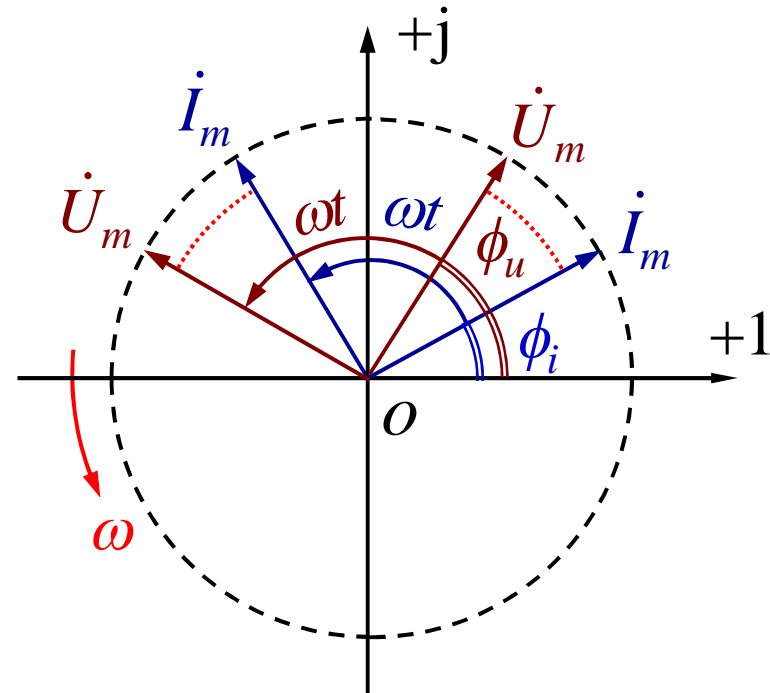

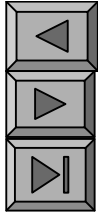

(2)

$$i = I_m \cos(\omega t + \phi_i) \quad \longrightarrow \quad \dot{I}_m = I_m \angle \phi_i$$

$$\frac{di}{dt} = \omega I_m \cos(\omega t + \phi_i + 90^\circ) = \text{Re}[\omega \dot{I}_m e^{j\omega t} e^{j\frac{\pi}{2}}]$$

$$= \text{Re}[j\omega \dot{I}_m e^{j\omega t}] \quad \longrightarrow \quad j\omega \dot{I}_m = \omega I_m \angle \phi_i + 90^\circ$$



$$\begin{array}{ccc} & j\omega & \\ & & 90^\circ \\ \omega I_m & & \\ \frac{d^n i}{dt^n} & \longleftrightarrow & (j\omega)^n \dot{I}_m \end{array}$$

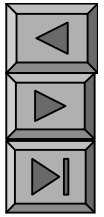

(3)

$$u = U_m \cos(\omega t + \phi_u) \longrightarrow \dot{U}_m = U_m \angle \phi_u$$
$$u dt = \frac{U_m}{\omega} \cos(\omega t + \phi_u - 90^\circ) = \operatorname{Re} \left[\frac{\dot{U}_m}{j\omega} e^{j\omega t} \right]$$



$$n \quad \dots \quad u dt \xleftrightarrow{j\omega} \frac{\dot{U}}{(j\omega)^n} \quad 90^\circ$$

(U_m/ω)

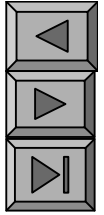

$$i_1 = 10\sqrt{2} \cos(314t + 60^\circ) \text{ A} \longrightarrow \dot{I}_1 = 10 \underline{60^\circ} \text{ A}$$

$$i_2 = 22\sqrt{2} \cos(314t - 150^\circ) \text{ A} \longrightarrow \dot{I}_2 = 22 \underline{-150^\circ} \text{ A}$$

$$\frac{di_1}{dt} \quad i_2 dt \quad i_1 + i_2$$

$$\frac{di_1}{dt} \longrightarrow j\omega \dot{I}_1 = j314 \times 10 \underline{60^\circ} = 3140 \underline{60^\circ + 90^\circ}$$

$$\frac{di_1}{dt} = 3140\sqrt{2} \cos(314t + 150^\circ)$$

$$i_2 dt \longrightarrow \frac{\dot{I}_2}{j\omega} = \frac{22 \underline{-150^\circ - 90^\circ}}{314} = 0.07 \underline{120^\circ}$$

$$i_2 dt = 0.07\sqrt{2} \cos(314t + 120^\circ)$$

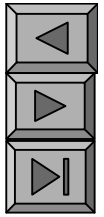

$$\dot{I}_1 = 10 \angle 60^\circ = 5 + j8.66 \text{ A} \quad \dot{I}_2 = 22 \angle -150^\circ = -19.05 - j11 \text{ A}$$

$$\dot{I}_1 + \dot{I}_2 = (5 - 19.05) + j(8.66 - 11) = (-14.05 - j2.34) \text{ A}$$

$$I = \sqrt{14.05^2 + 2.34^2} = 14.24 \text{ A}$$

$$\phi_i \quad 3$$

$$\phi_i = -180^\circ + \operatorname{arctg} \frac{-2.34}{-14.05}$$

$$\dot{I}_1 + \dot{I}_2 = 14.24 \angle -170.54^\circ \text{ A}$$

$$i_1 + i_2 = 14.24 \sqrt{2} \cos(314t - 170.54^\circ) \text{ A}$$

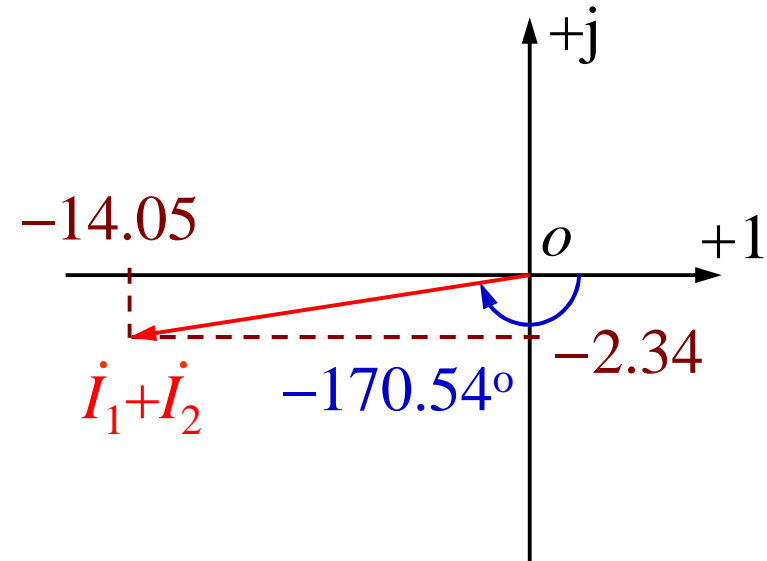

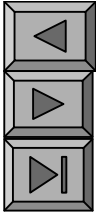

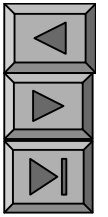

2. VCR

(1)

$$u_R = R i_R \longrightarrow \underline{\dot{U}_R = R \dot{I}_R}$$
$$\underline{\dot{I}_R = G \dot{U}_R}$$



$$U_R = R I_R \quad I_R = G U_R$$

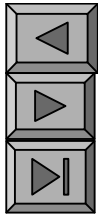
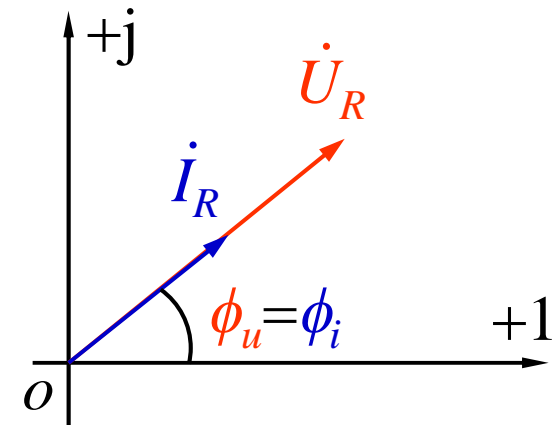
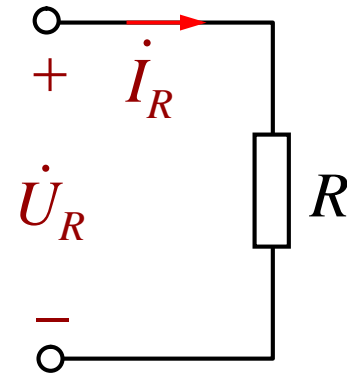

2010

\$#ò

ñ

)Iq

H

H

us

#6{

I

qVwW1SGgv†

us

#6{

I

qVwFOA6wFO

d

(3)

$$i_C = C \frac{du_C}{dt} \longrightarrow \dot{I}_C = C(j\omega \dot{U}_C)$$

$$\dot{U}_C = \frac{1}{j\omega C} \dot{I}_C$$

$$\dot{U}_C = -j \frac{1}{\omega C} \dot{I}_C$$

☞ C

$90^\circ!$

$90^\circ!$

$$U_C = \frac{1}{\omega C} I_C$$

$$\frac{U_C}{I_C} = \frac{1}{\omega C}$$

☞ $(1/\omega C)$

f

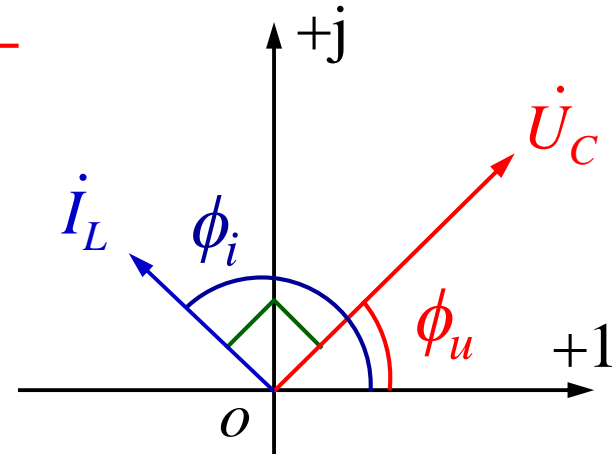
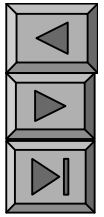
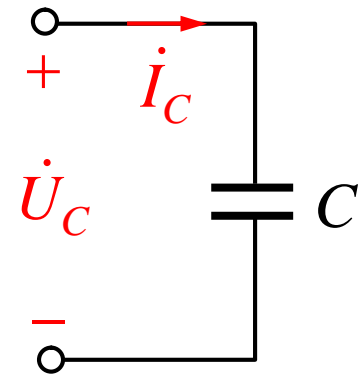

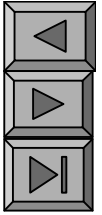

4.



$\mu \quad g \quad r \quad \beta$

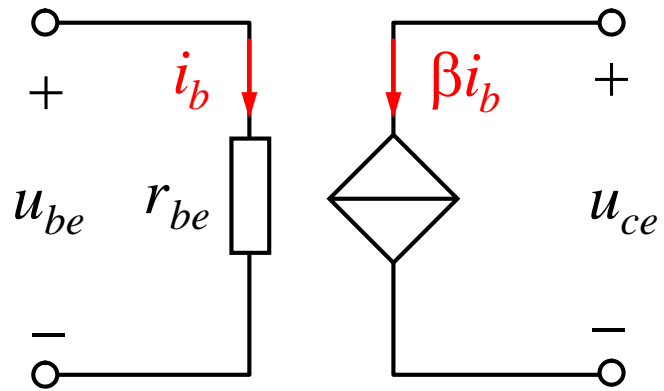

CCCS

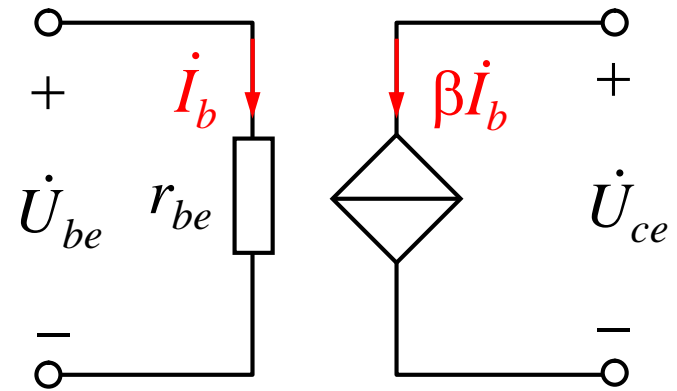

CCCS

$$u(t) = 120 \sqrt{2} \cos(5t) \text{ V}$$

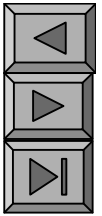
 $i(t)$

$$\dot{U} = 120 \angle 0^\circ \text{ V}$$

$$\frac{1}{\omega C} = \frac{1}{5 \times 0.02} = 10 \Omega$$

$$\omega L = 5 \times 4 = 20 \Omega$$

$$\dot{I}_R = \frac{\dot{U}}{R} = \frac{120}{15} = 8 \text{ A}$$

$$\dot{I}_C = \frac{\dot{U}}{-j \frac{1}{\omega C}} = \frac{120}{-j10} = j12 \text{ A}$$

$$\dot{I}_L = \frac{\dot{U}}{j\omega L} = \frac{120}{j20} = -j6 \text{ A}$$

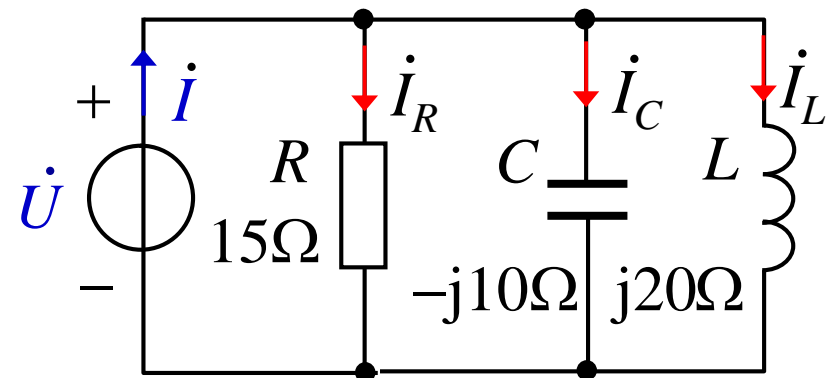
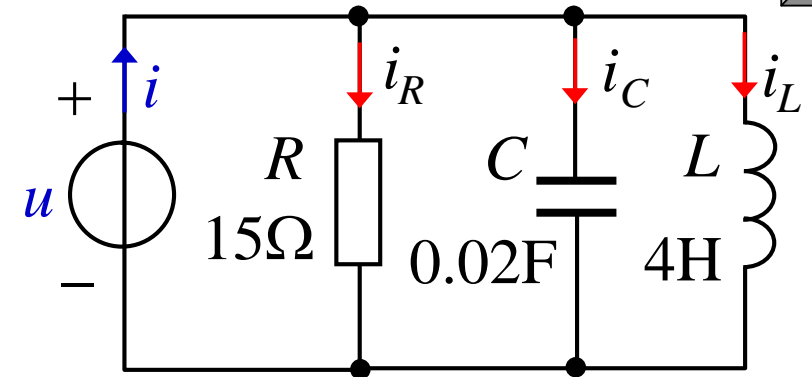

$$\begin{aligned} \dot{I} &= \dot{I}_R + \dot{I}_C + \dot{I}_L \\ &= 8 + j12 - j6 \text{ A} \end{aligned}$$

$$u(t) = 120 \sqrt{2} \cos(5t) \text{ V}$$

$$\dot{I} = 8 + j6 = 10 \angle 36.9^\circ \text{ A}$$

$$i(t) = 10 \sqrt{2} \cos(5t + 36.9^\circ) \text{ A}$$

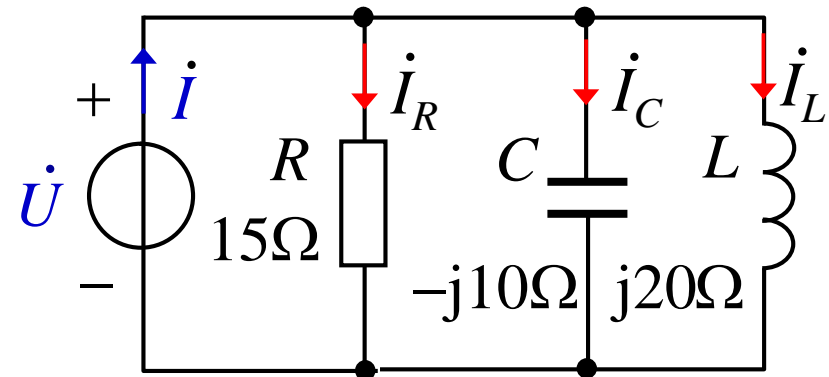
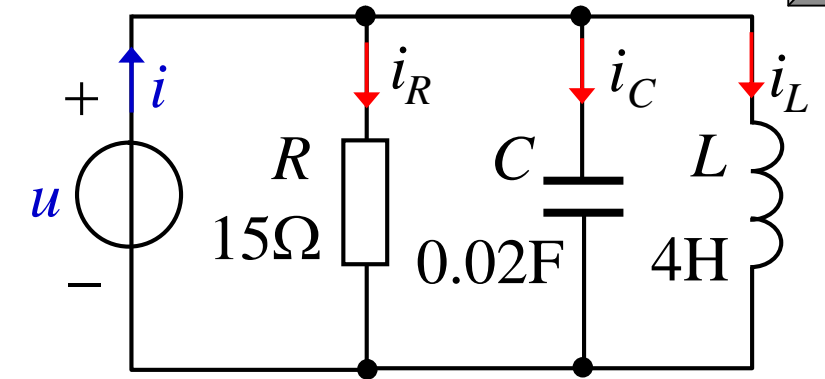
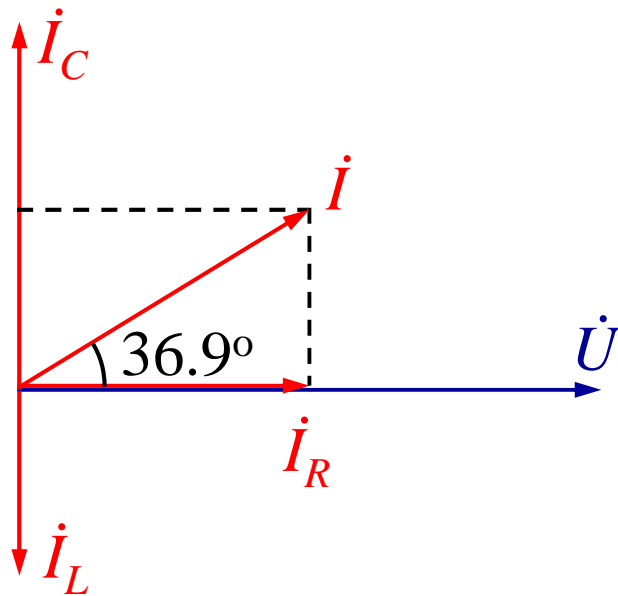

$$\begin{aligned} \dot{I} &= \dot{I}_R + \dot{I}_C + \dot{I}_L \\ &= 8 + j12 - j6 \text{ A} \end{aligned}$$

