

1.

2.



KVL

VCR

KCL

§ 6 1

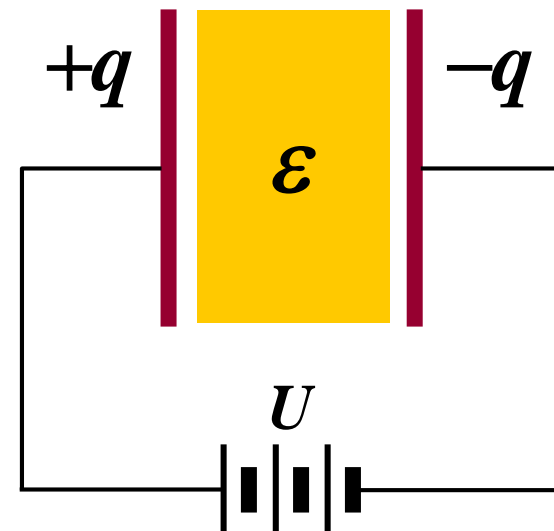

(1)



2 30kV



()

(2)

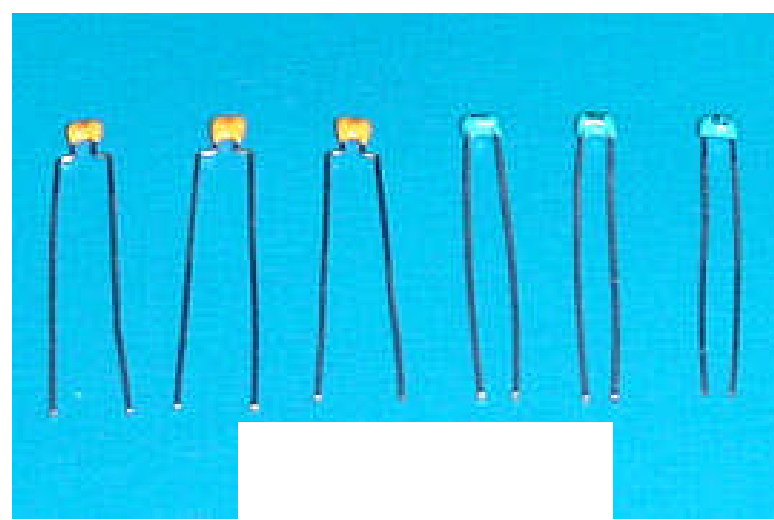
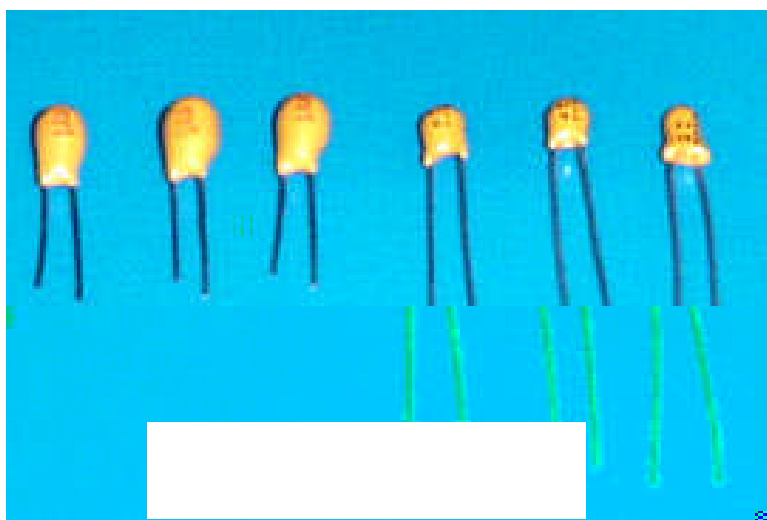

(3)

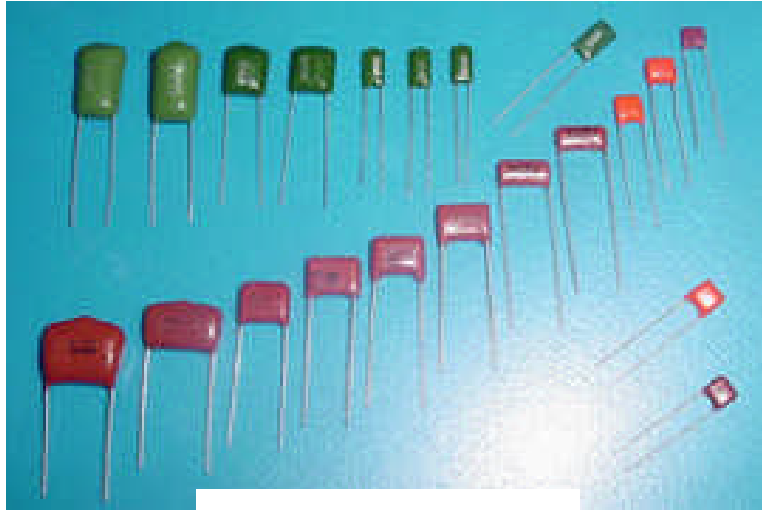

0.1-1000F



(4)

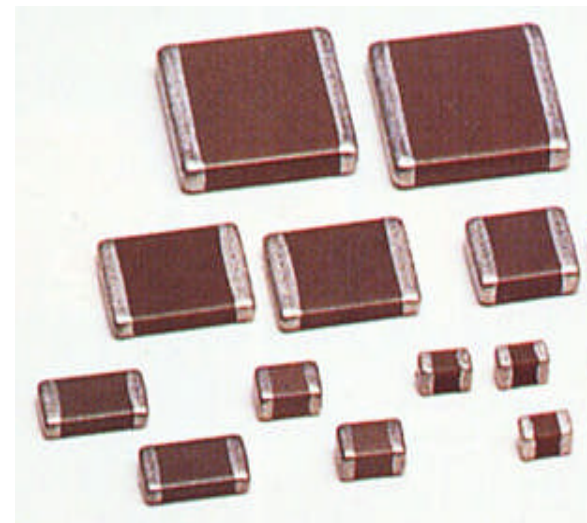
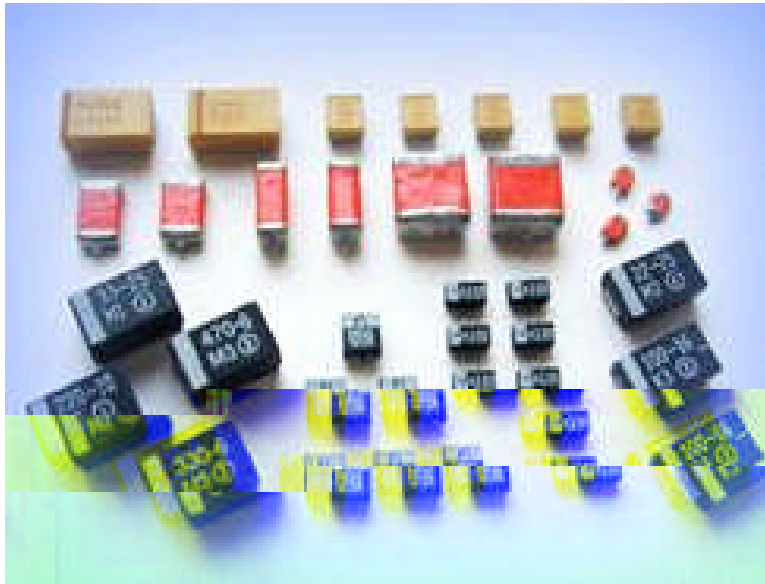

(5)

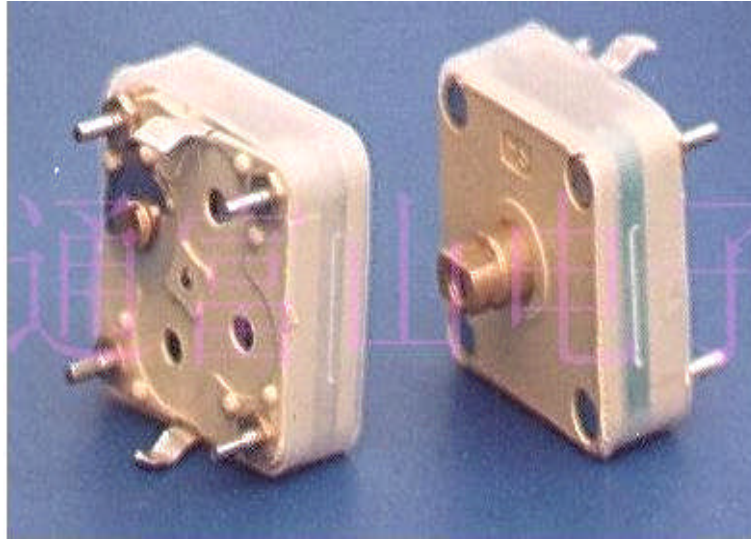

1.

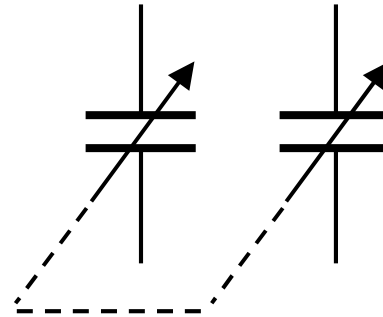
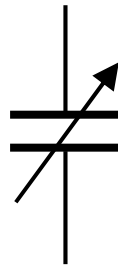
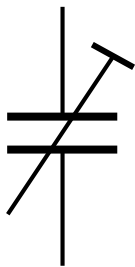
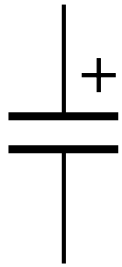
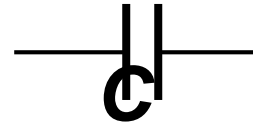

2.

u q u

q

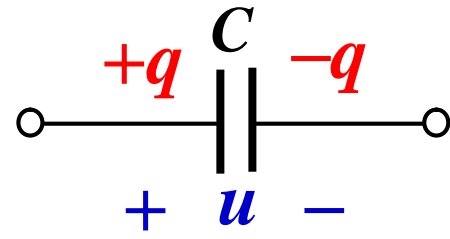

q

$$q = C u$$

u

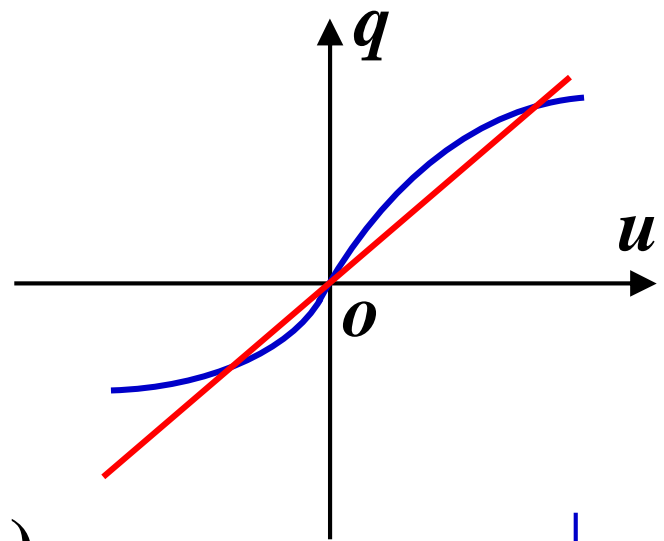

F()

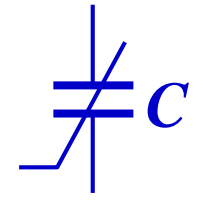

C

μF

pF



3.

$C \quad i \quad u$

$$i = \frac{dq}{dt} = \frac{d(Cu)}{dt} \quad C$$

$$i = C \frac{du}{dt}$$

i

u

u

u

()

$i = 0$

“

”

i

u

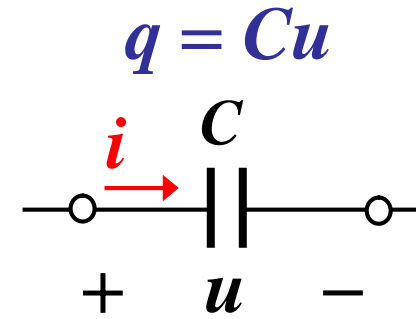

$$i = \frac{dq}{dt}$$

$$q(t) = \int_{t_0}^t i(\xi) d\xi = \int_{t_0}^t i(\xi) d\xi + \int_{t_0}^t i(\xi) d\xi$$

$$q(t) = q(t_0) + \int_{t_0}^t i(\xi) d\xi$$

$$q = C u$$

$$u(t) = u(t_0) + \frac{1}{C} \int_{t_0}^t i(\xi) d\xi$$

—∞

$$t_0 \quad i \quad t_0 \quad u(t_0) \quad t_0$$

u i

u(t₀)



3. /

u i

$$p = ui = u C \frac{du}{dt}$$

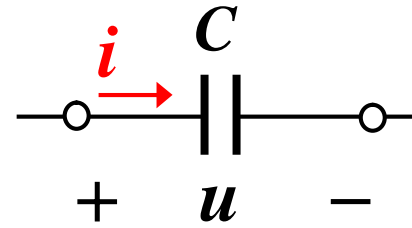

&

(2)

☞ t -

$$w_c = \int_{-}^t C u(\xi) \frac{du(\xi)}{dt} dt$$

$$\underline{\underline{w_c = \frac{1}{2} C u^2(t) - \frac{1}{2} C u^2(-)}}}$$

0

t_1 t_2

$$W_c = \frac{1}{2} C u^2(t_2) - \frac{1}{2} C u^2(t_1) = W_c(t_2) - W_c(t_1)$$

$$w_c = \frac{1}{2} C u^2(t) \quad 0$$

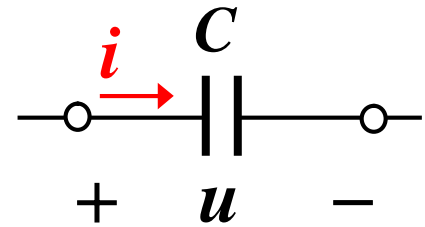
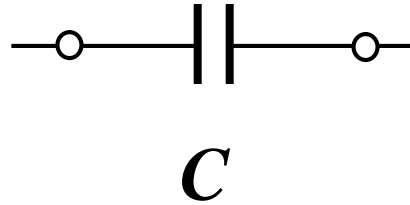

$$q = Cu$$

$$i = C \frac{du}{dt} \quad u = \frac{1}{C} \int_{-}^t i dt \quad (\quad)$$

$$1 \text{ F} = 10^6 \mu\text{F} = 10^{12} \text{ pF}$$

$$w_c(t) = \frac{1}{2} Cu^2(t)$$

$$u_S(t) = \begin{cases} 0 & t & 0 \\ 2t & 0 & t & 1s \\ -2t+4 & 1 & t & 2s \\ 0 & t & 2s \end{cases}$$

$$i(t) = C \frac{du_S}{dt} = \begin{cases} 0 & t & 0 \\ 1 & 0 & t & 1s \\ -1 & 1 & t & 2s \\ 0 & t & 2s \end{cases}$$

$$p(t) = u_S(t) i(t) \quad w(t) = \frac{1}{2} C u_S^2(t)$$

i $p(t)$ $w(t)$

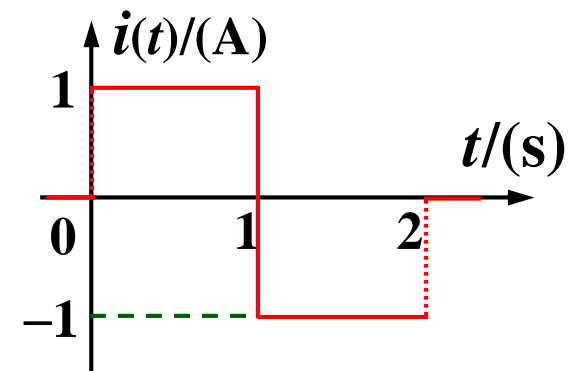
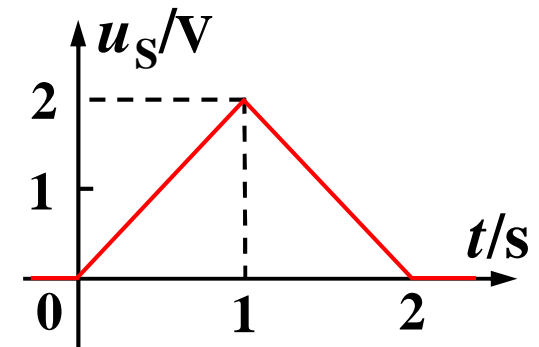
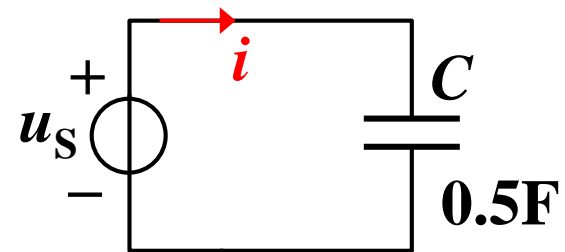

$$u_S(t) = \begin{cases} \mathbf{0} & t & \mathbf{0} \\ \mathbf{2t} & \mathbf{0} & t & \mathbf{1s} \\ \mathbf{-2t+4} & \mathbf{1} & t & \mathbf{2s} \\ \mathbf{0} & t & \mathbf{2s} \end{cases}$$

$$i(t) = \begin{cases} \mathbf{0} & t & \mathbf{0} \\ \mathbf{1} & \mathbf{0} & t & \mathbf{1s} \\ \mathbf{-1} & \mathbf{1} & t & \mathbf{2s} \\ \mathbf{0} & t & \mathbf{2s} \end{cases}$$

$$p(t) = u_S(t)i(t) = \begin{cases} \mathbf{0} & t & \mathbf{0} \\ \mathbf{2t} & \mathbf{0} & t & \mathbf{1s} \\ \mathbf{2t-4} & \mathbf{1} & t & \mathbf{2s} \\ \mathbf{0} & t & \mathbf{2s} \end{cases}$$

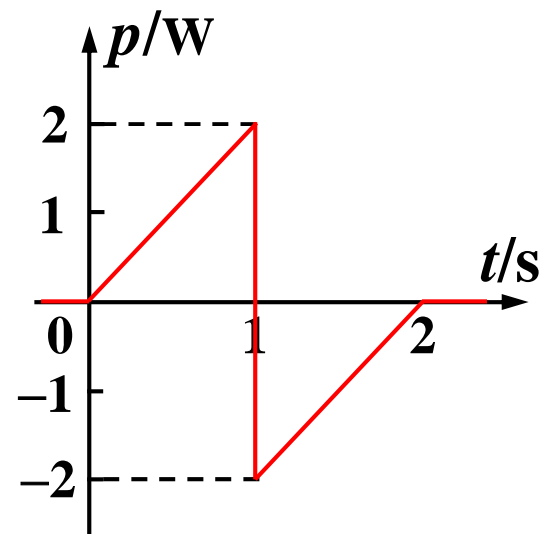
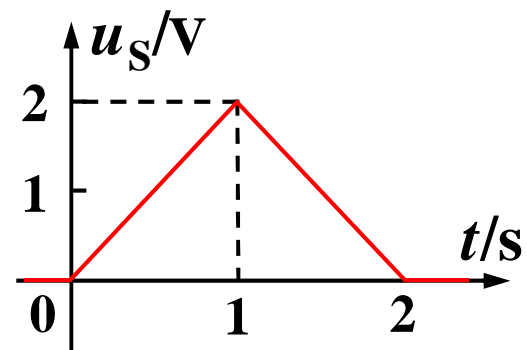
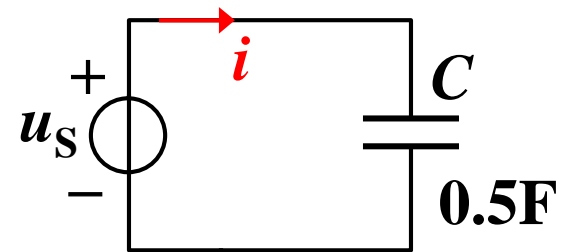

$$u_S(t) = \begin{cases} 0 & t < 0 \\ 2t & 0 \leq t < 1 \\ -2t+4 & 1 \leq t < 2 \\ 0 & t \geq 2 \end{cases}$$

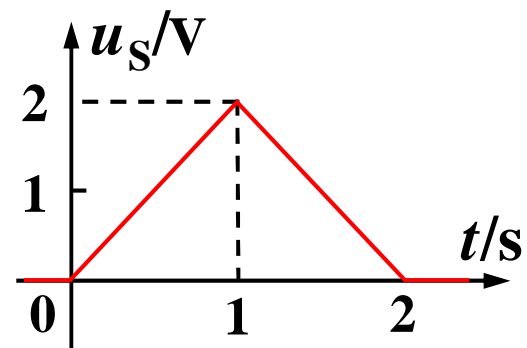
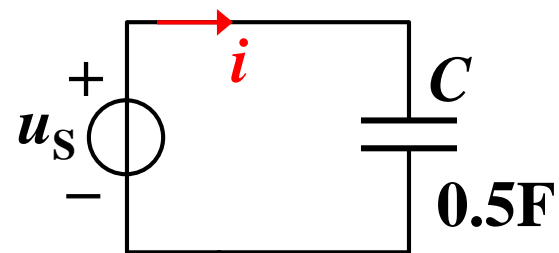

$$w(t) = \frac{1}{2} C u_S^2(t) = \begin{cases} 0 & t < 0 \\ t^2 & 0 \leq t < 1 \\ (2-t)^2 & 1 \leq t < 2 \\ 0 & t \geq 2 \end{cases}$$

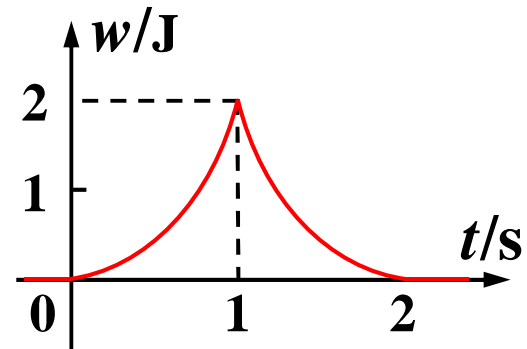

§ 6 2



Φ_L N

$$\Psi_L = N \Phi_L$$

Φ_L Ψ_L

Ψ_L i

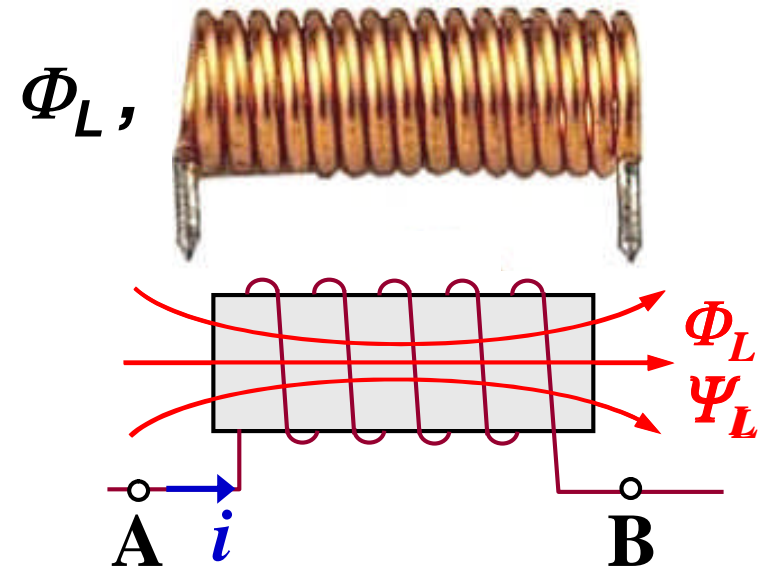

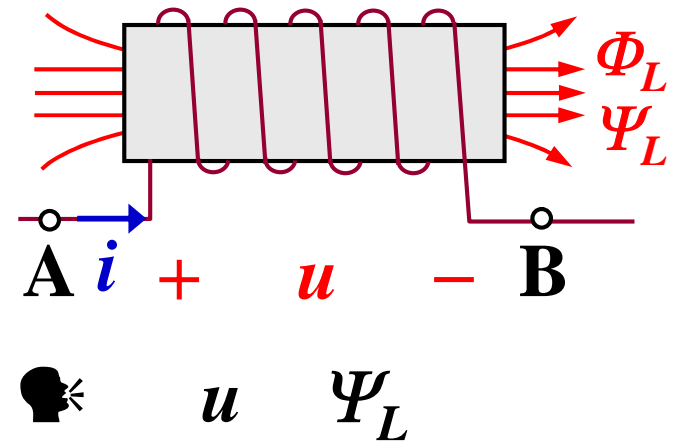

$$u = \frac{d\Psi_L}{dt}$$

$$u = \frac{d\Psi_L}{dt}$$



(1)

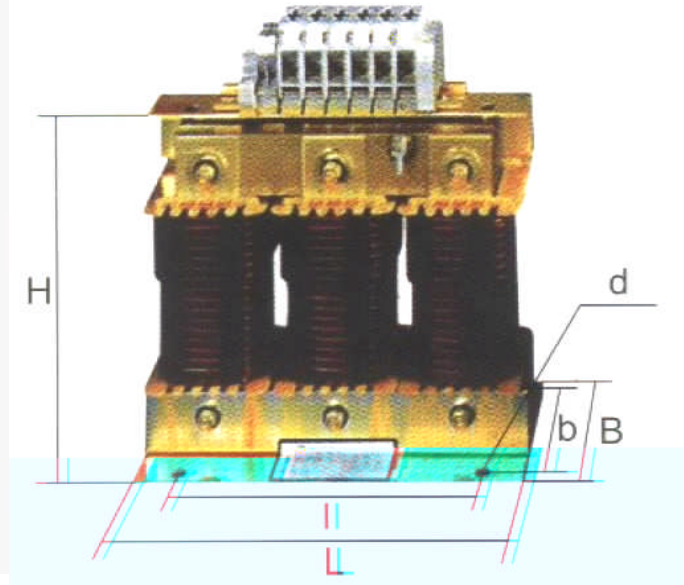
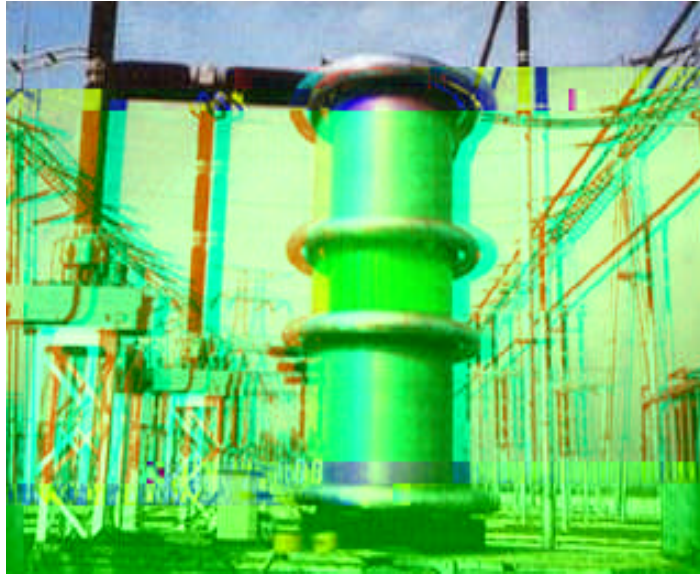

(2)

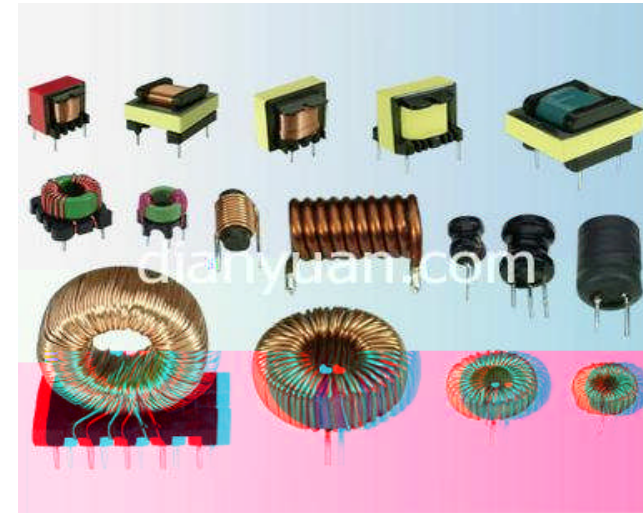
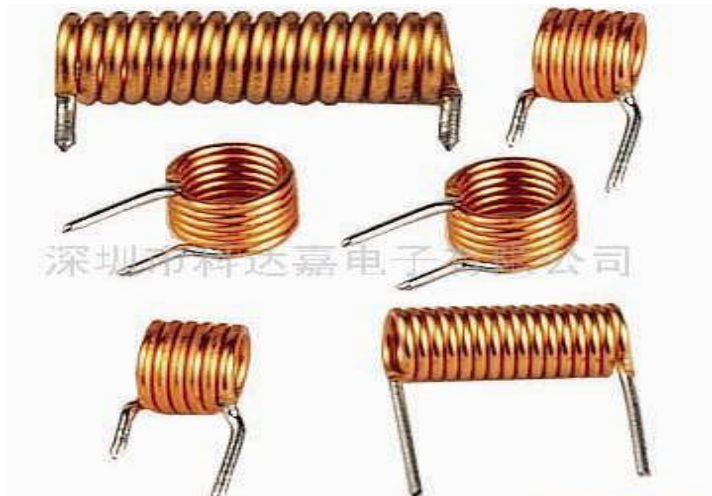
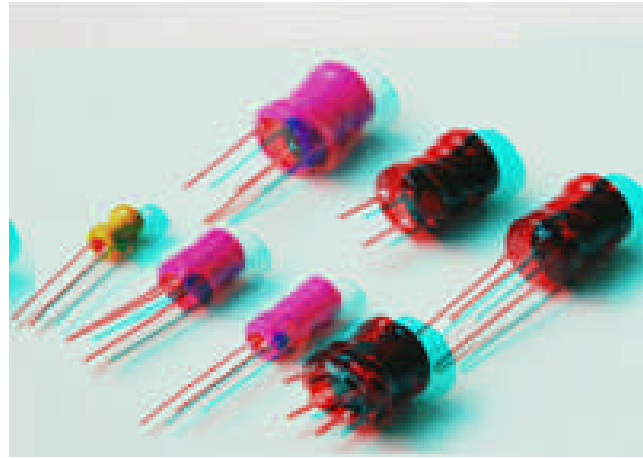

()

(3)

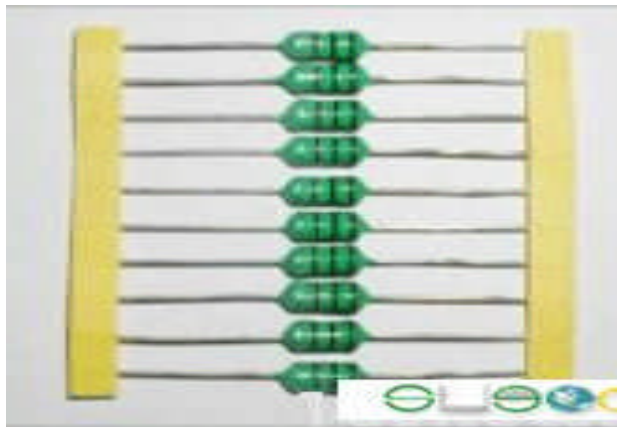
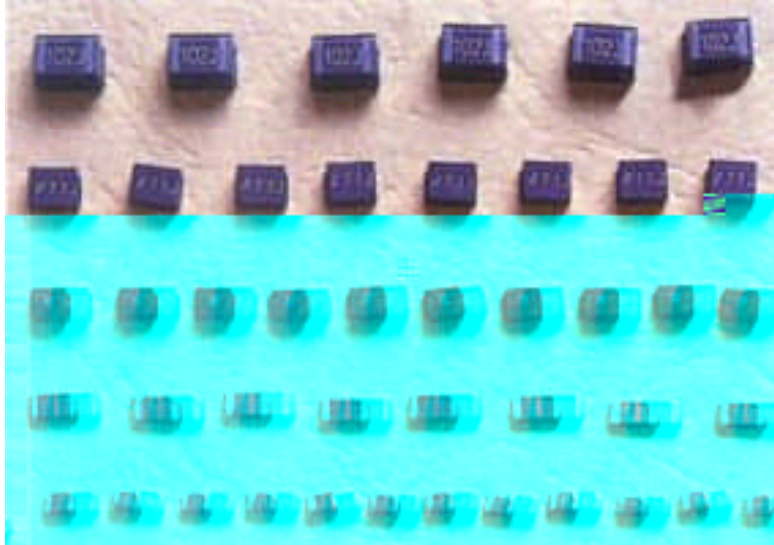

1.

ψ i

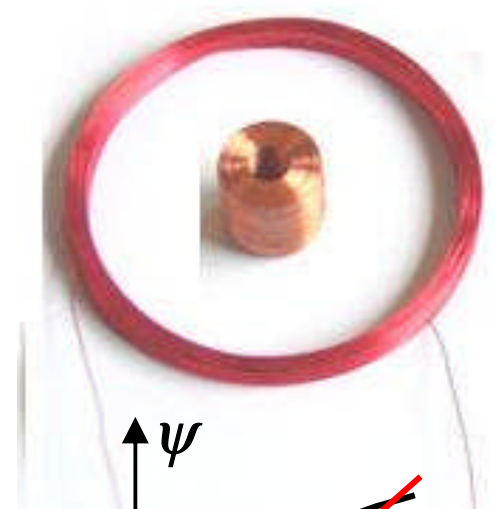

2.

ψ

i
 $\psi \sim i$

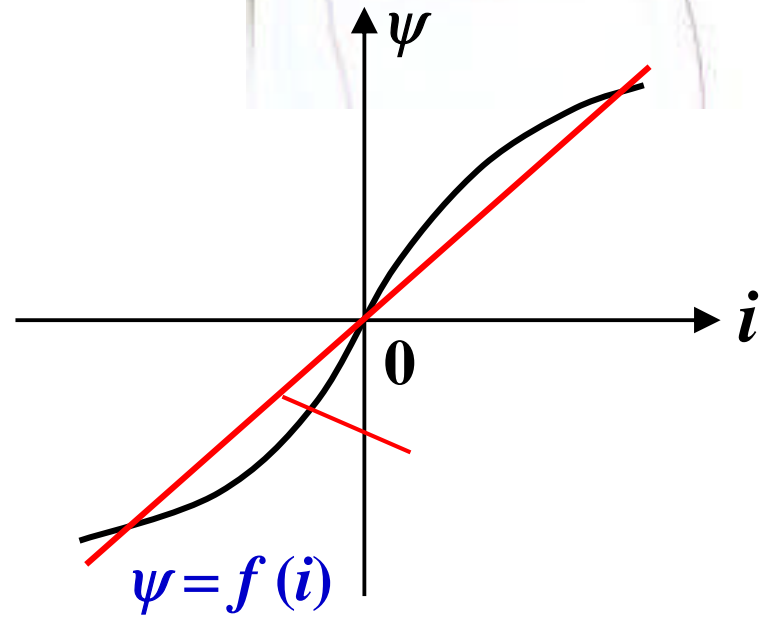

(1)

L

$$\psi(t) = L i(t)$$

(2)

$$\psi(t) = L i(t)$$

Ψ

Wb

i

A

L

H

μH

mH

$$1\text{H} = 10^3\text{mH} = 10^6\mu\text{H}$$

(3)

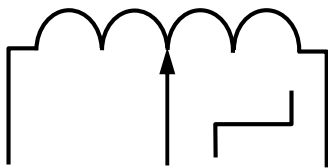
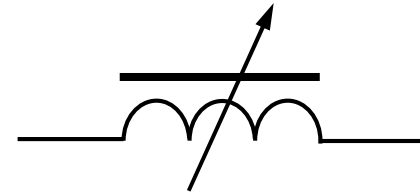

L

3.

i u

i Ψ_L

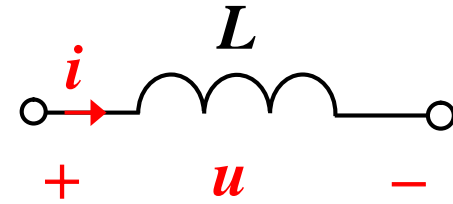

$$\Psi_L = Li \quad u = \frac{d\Psi_L}{dt} \longrightarrow u = L \frac{di}{dt} \quad \text{VCR}$$

u

i

i

i

()

$u=0$

u

i

$$i = \frac{1}{L} \int_{-\infty}^t u \, d\xi = \frac{1}{L} \int_{-\infty}^{t_0} u \, d\xi + \frac{1}{L} \int_{t_0}^t u \, d\xi$$

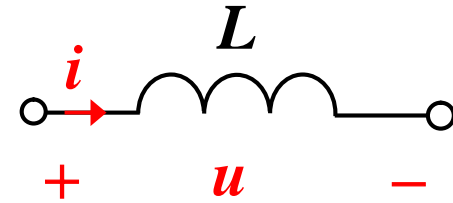

$$i = i(t_0) + \frac{1}{L} \int_{t_0}^t u \, d\xi$$

$-\infty$

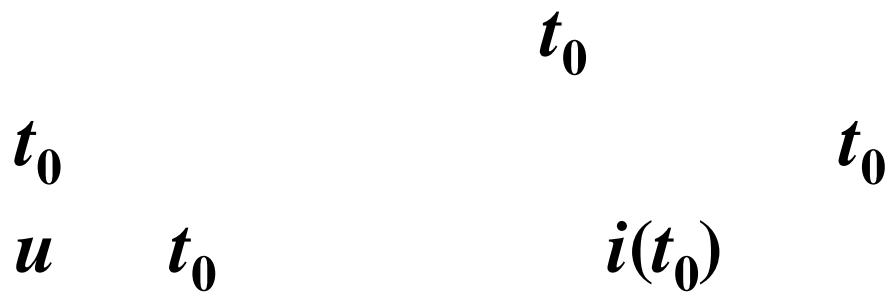

$$i = i(t_0) + \frac{1}{L} \int_{t_0}^t u \, d\xi \quad L$$

$$\Psi_L = \Psi_L(t_0) + \int_{t_0}^t u \, d\xi$$

$u \quad i$

$$u = -L \frac{di}{dt} \quad i = i(t_0) - \frac{1}{L} \int_{t_0}^t u \, d\xi$$

$i(t_0)$

4.

(1)

$$p = ui = L \frac{di}{dt} i$$

$$p = 0$$

$$p = 0$$

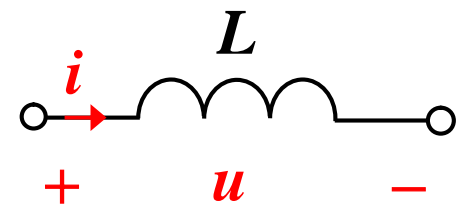

(2)

$-\infty \sim t$

$$w_L = \int_{-\infty}^t L i(\xi) \frac{di(\xi)}{dt} dt = L \int_{i(-\infty)}^{i(t)} i(\xi) di(\xi)$$

$$w_L = \frac{1}{2} Li^2(t) - \frac{1}{2} Li^2(-\infty)$$

$$t = -\infty \quad i(-\infty) = 0$$

$$w_L = \frac{1}{2} Li^2(t)$$

$$\begin{array}{c}
 t_1 \quad t_2 \\
 W_L = \frac{1}{2} Li^2(t_2) - \frac{1}{2} Li^2(t_1) = W_L(t_2) - W_L(t_1)
 \end{array}$$

$$|i| \quad W_L \quad 0$$

$$|i| \quad W_L \quad 0$$



$$\Psi_L = f(i)$$

$$i = h(\Psi_L)$$



L

$$\Psi_L = Li$$

$$u = L \frac{di}{dt} \quad i = \frac{1}{L} \int^t u \, dt$$

$$1 \text{ H} = 10^3 \text{ mH} = 10^6 \mu\text{H}$$

$$w_L(t) = \frac{1}{2} Li^2(t)$$



1.

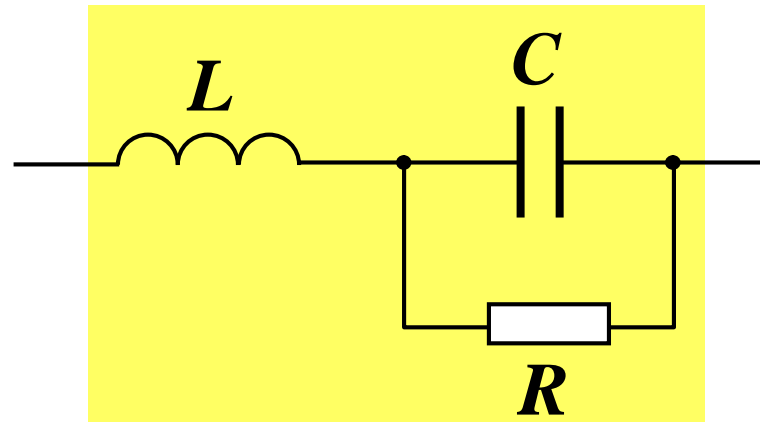
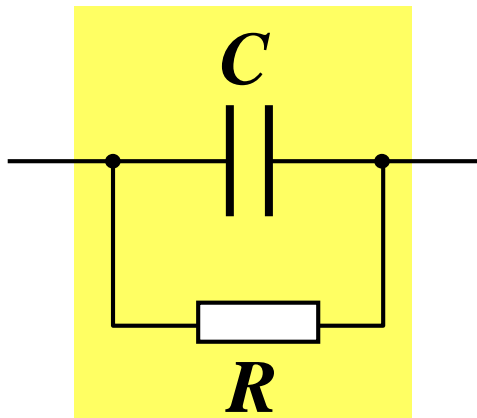
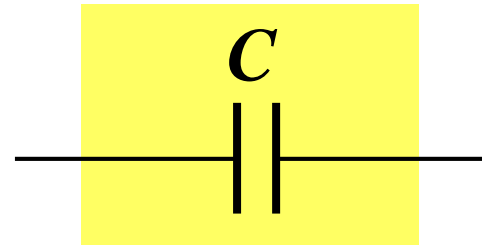
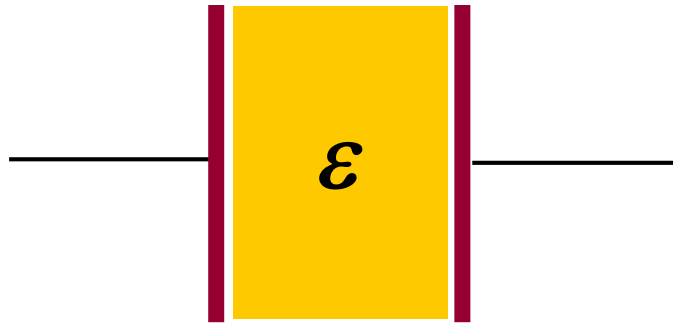

2.

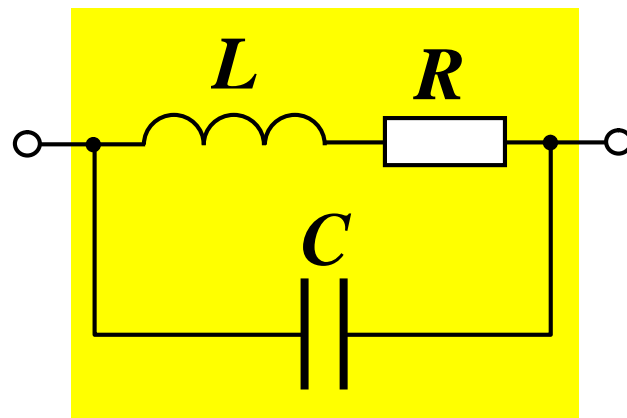
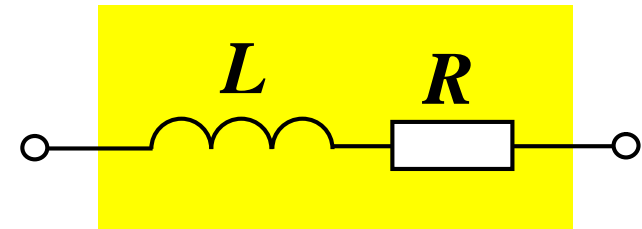
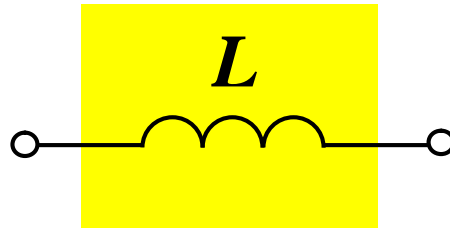
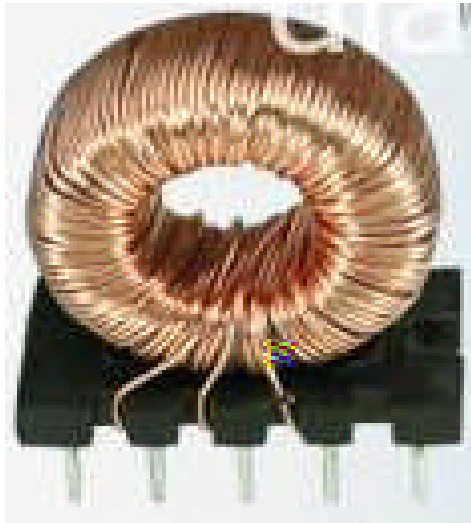

$$6-4 \quad L=4\text{H} \quad i(0)=0$$

$$t=2\text{s} \quad t=3\text{s} \quad t=4\text{s}$$

VCR

$$i = i(t_0) + \frac{1}{L} \int_{t_0}^t u \, d\xi$$

$$u(t) = \begin{cases} 10\text{V} & 2\text{s} & t & 0 \\ 0 & 3\text{s} & t & 2\text{s} \\ 10t-40 & 4\text{s} & t & 3\text{s} \end{cases}$$

$$t=1\text{s}$$

$$i(1) = 0 + \frac{1}{4} \int_0^1 10 \, dt = \frac{10}{4} t \Big|_0^1 = [2.5(1-0)] = 2.5\text{A}$$

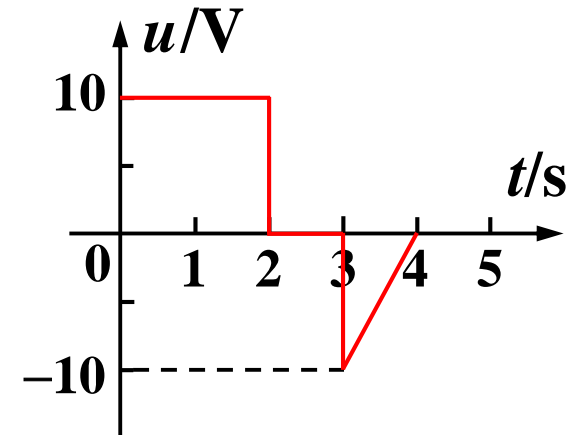
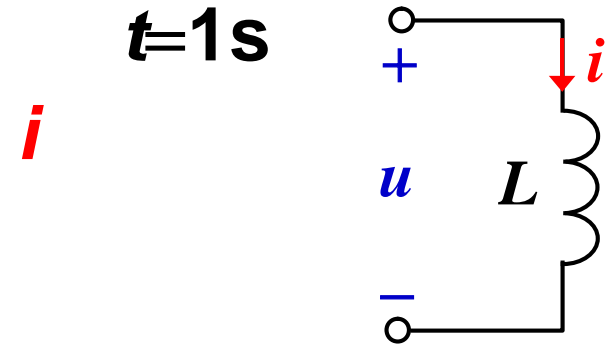

$$i(1) = 2.5\text{A}$$

$$t=2\text{s}$$

$$i(2) = 0 + \frac{1}{4} \int_0^2 10 dt = \frac{10}{4} t \Big|_0^2 = [2.5(2-0)] = 5\text{A}$$

$$i(2) = 2.5 + \frac{1}{4} \int_1^2 10 dt = 5\text{A}$$

$$t=3\text{s}$$

$$i(3) = 5 + \frac{1}{4} \int_1^3 0 dt = 5\text{A}$$

$$t=4\text{s}$$

$$i(4) = 5 + \frac{1}{4} \int_3^4 (10t-40) dt = 5 + \frac{1}{4} (5t^2-40t) \Big|_3^4 = 3.75\text{A}$$

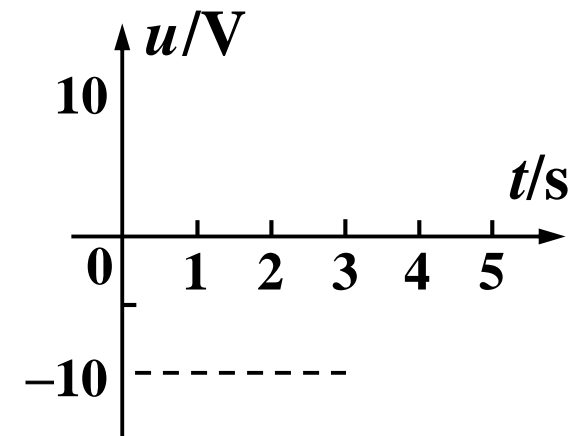
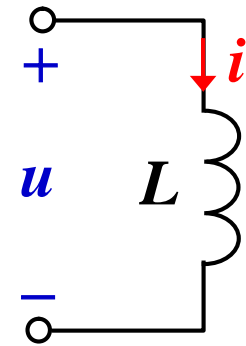

§ 6 3

1.

(1)

$$u_1 = u_1(t_0) + \frac{1}{C_1} \int_{t_0}^t i(\xi) d\xi$$

$$u_2 = u_2(t_0) + \frac{1}{C_2} \int_{t_0}^t i(\xi) d\xi$$

$$u = u_1 + u_2 = u_1(t_0) + u_2(t_0) + \left(\frac{1}{C_1} + \frac{1}{C_2} \right) \int_{t_0}^t i(\xi) d\xi$$

$$= u(t_0) + \frac{1}{C} \int_{t_0}^t i(\xi) d\xi$$

$$u(t_0) = u_1(t_0) + u_2(t_0)$$

VCR KVL

$$\frac{1}{C} = \frac{1}{C_1} + \frac{1}{C_2}$$

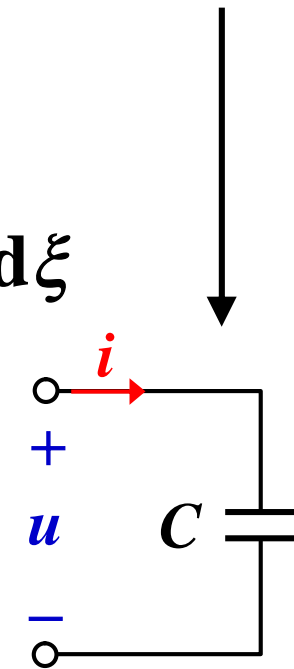
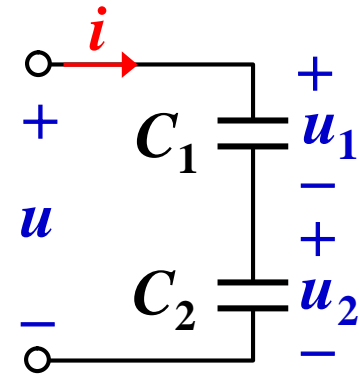

n

$$\frac{1}{C_{\text{eq}}} = \frac{1}{C_1} + \frac{1}{C_2} + \dots + \frac{1}{C_n}$$

$$u(t_0) = u_1(t_0) + u_2(t) + \dots + u_n(t_0)$$

()

$$u(t_0) = 0$$

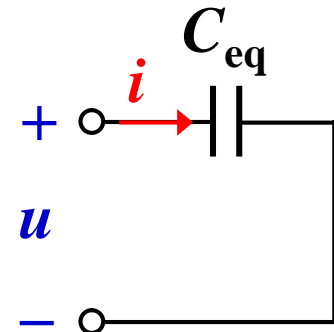
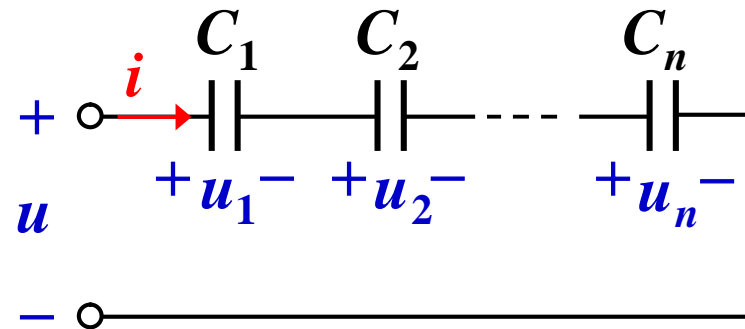

(2)

$$u_1 = \frac{1}{C_1} \int_0^t i(\xi) d\xi \dots\dots$$

$$u_2 = \frac{1}{C_2} \int_0^t i(\xi) d\xi \dots\dots$$

$$u = \frac{1}{C} \int_0^t i(\xi) d\xi \dots\dots$$

$$\div \quad \frac{u_1}{u} = \frac{C}{C_1} \quad \longrightarrow \quad u_1 = \frac{C}{C_1} u = \frac{C_2}{C_1 + C_2} u$$

$$u_2 = \frac{C}{C_2} u = \frac{C_1}{C_1 + C_2} u$$

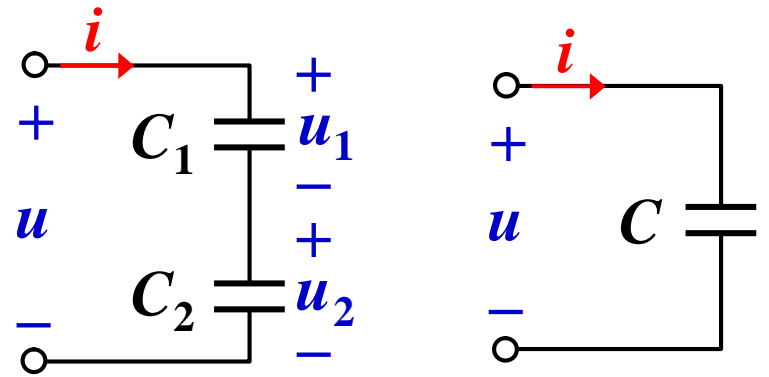

$$C = \frac{C_1 C_2}{C_1 + C_2}$$

2.

(1)

$$i_1 = C_1 \frac{du}{dt} \quad i_2 = C_2 \frac{du}{dt}$$

$$i = i_1 + i_2 = (C_1 + C_2) \frac{du}{dt} = C \frac{du}{dt}$$

$$C = C_1 + C_2$$

(2)

$$\frac{i_1}{i} = \frac{C_1}{C} \quad \Rightarrow \quad i_1 = \frac{C_1}{C} i \quad i_2 = \frac{C_2}{C} i$$

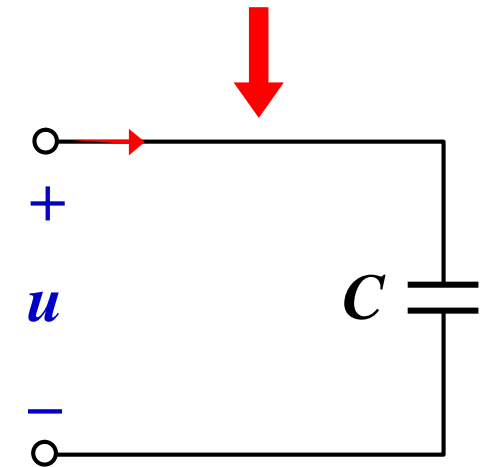
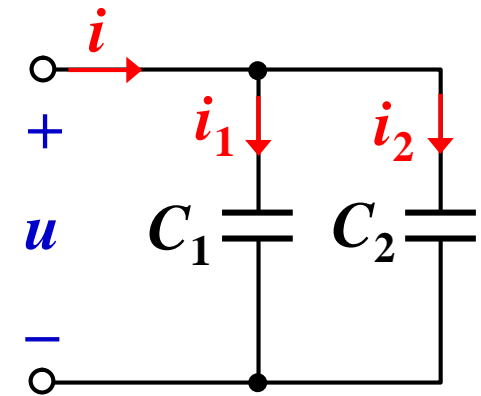

(3) n

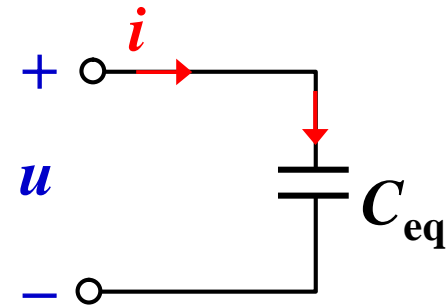
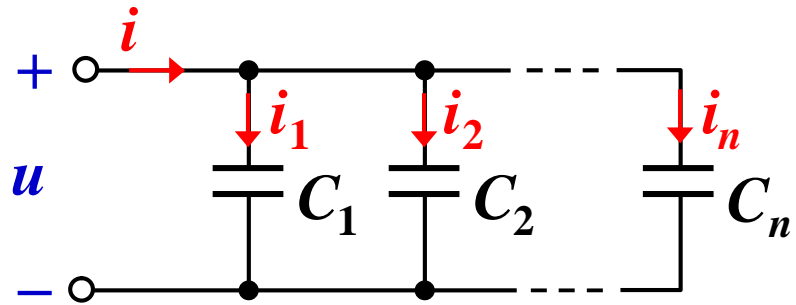

VCR

$$u(t_0) = u_1(t_0) = u_2(t_0) = \cdots = u_n(t_0)$$

$$C_{eq} = C_1 + C_2 + \cdots + C_n$$

3.

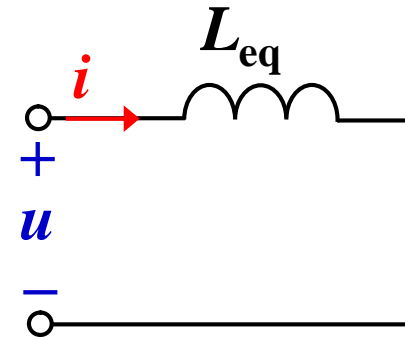
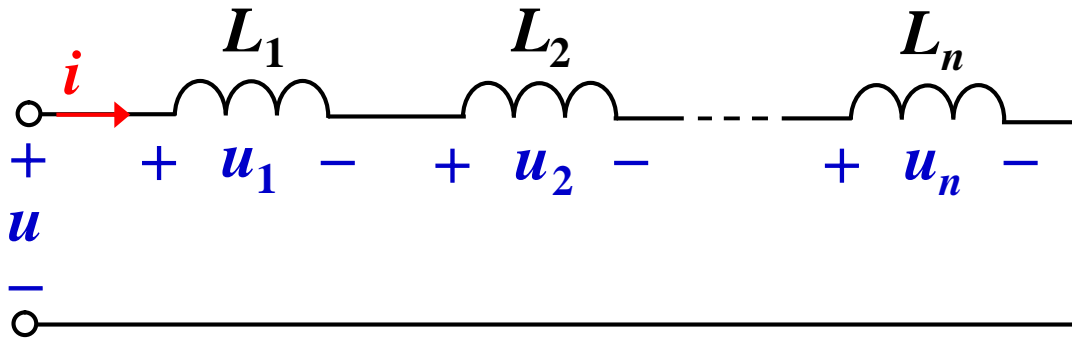

VCR

(1)

$$i(t_0) = i_1(t_0) = i_2 = t$$

4.

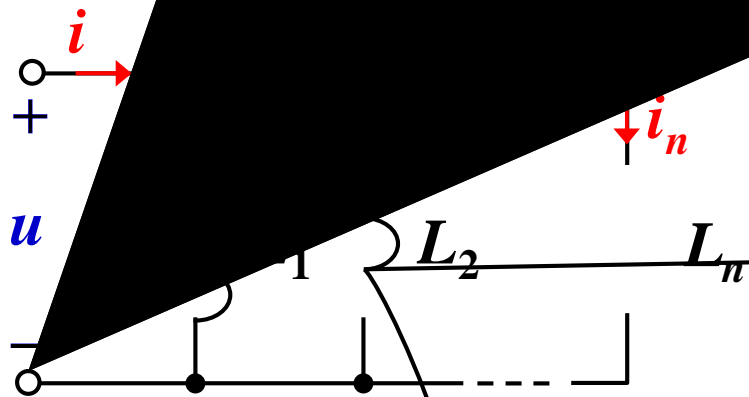

$$\frac{1}{L_{\text{eq}}} = \frac{1}{L_1} + \frac{1}{L_2} + \dots + \frac{1}{L_n}$$

(2)

$$i(t_0) = i_1(t_0) + i_2(t) + \dots + i_n(t_0)$$

